

# 能帶

$N=10$

$N=2000$

$N \rightarrow 2000$

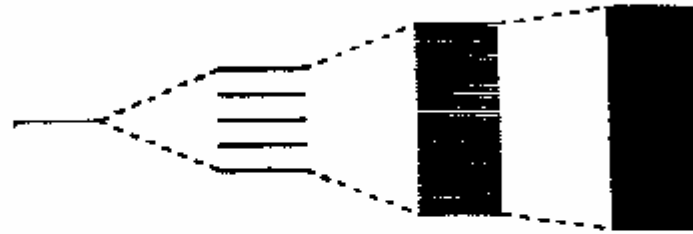

# 能帶

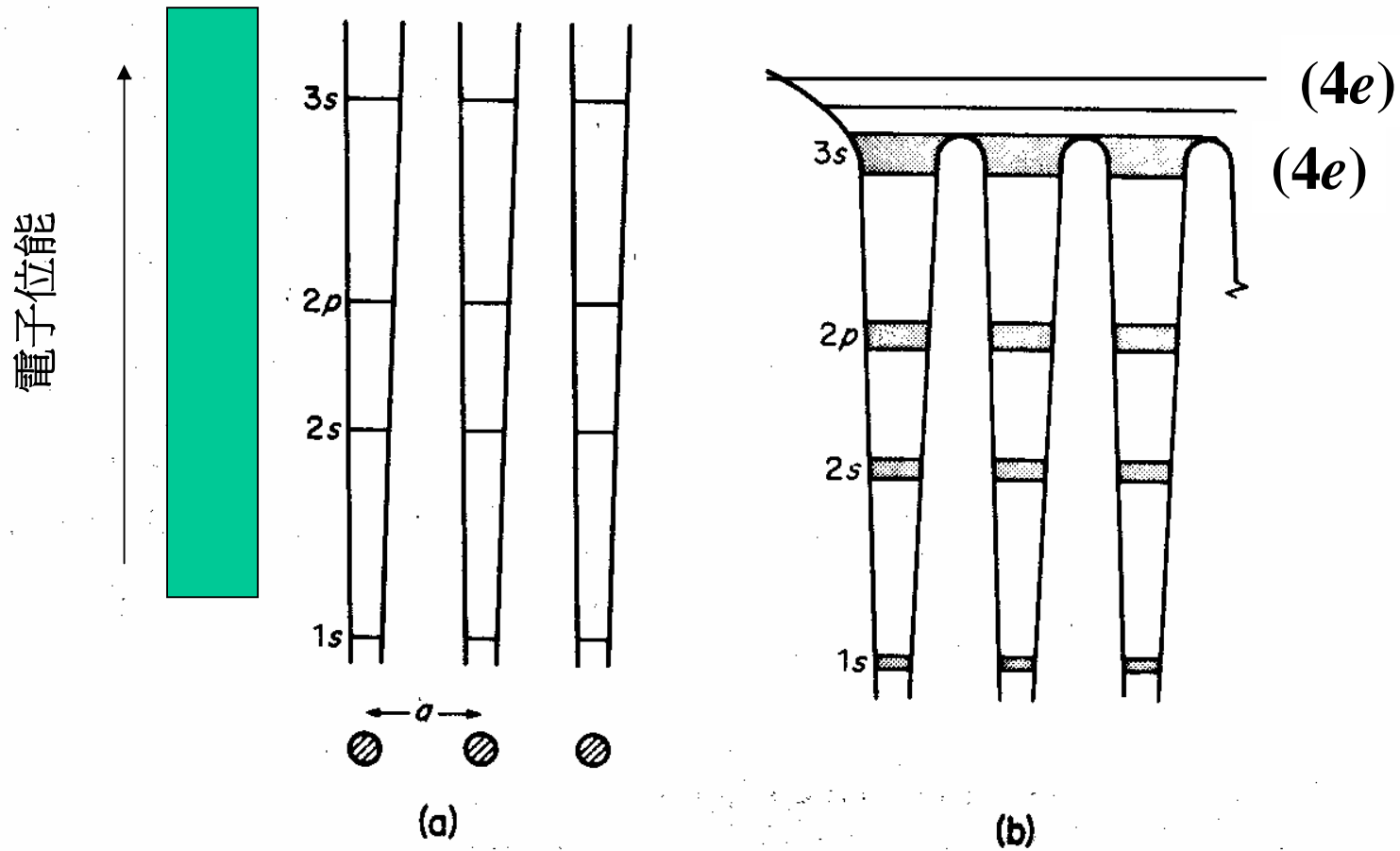
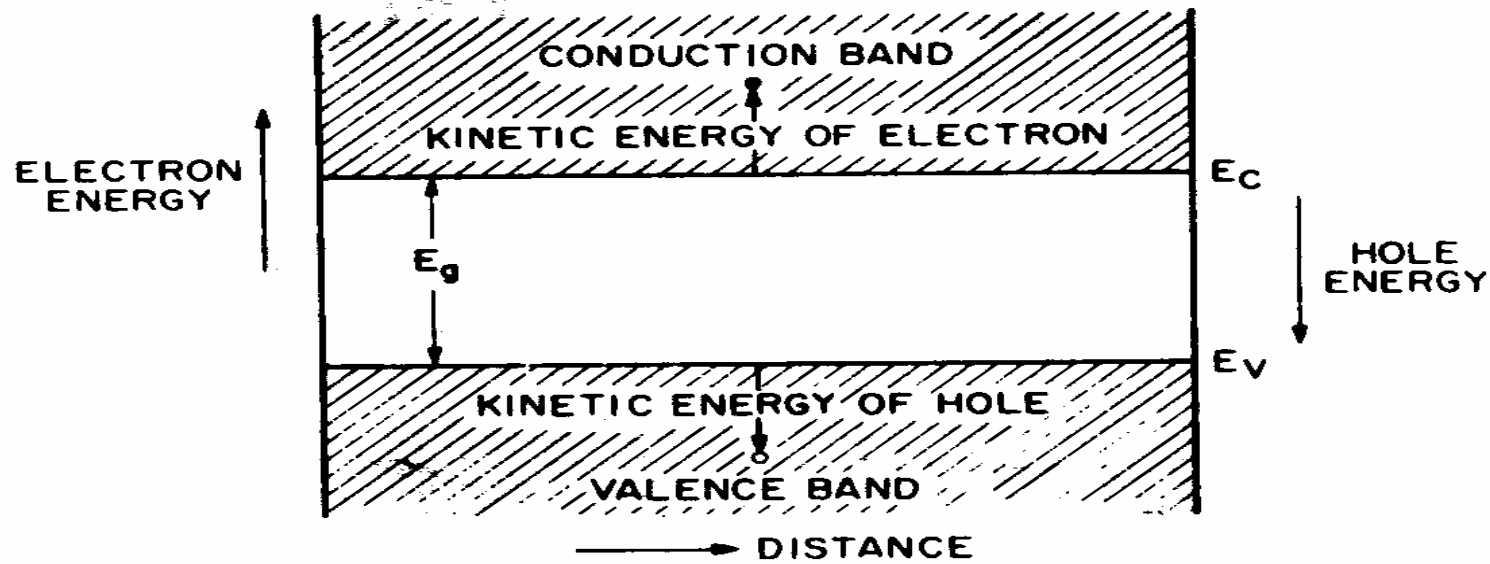
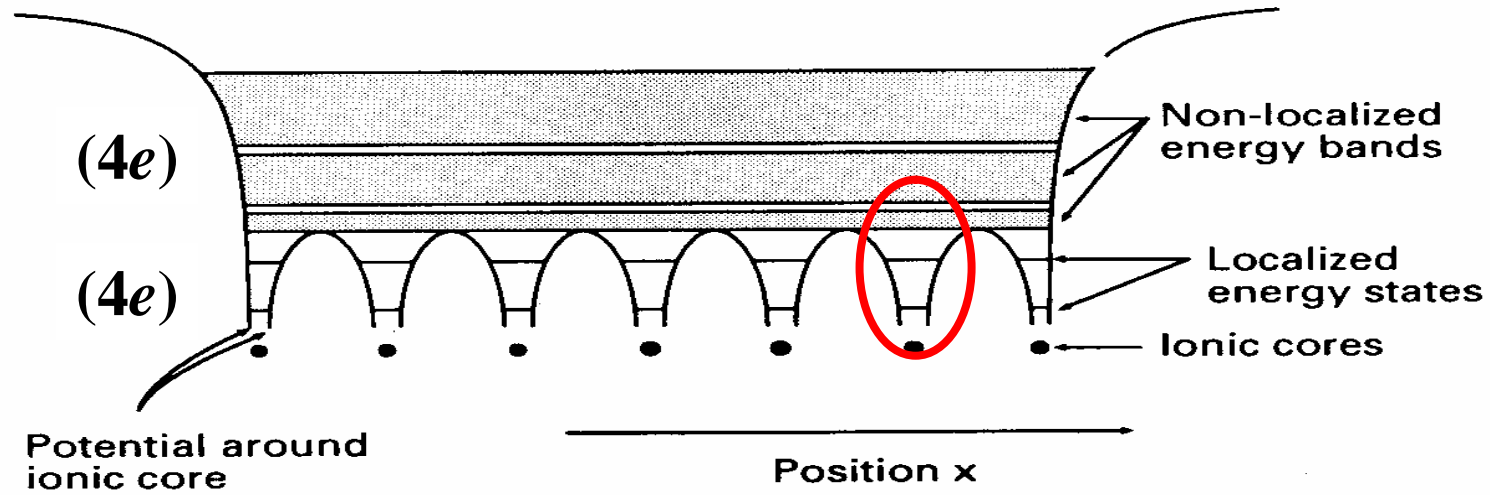
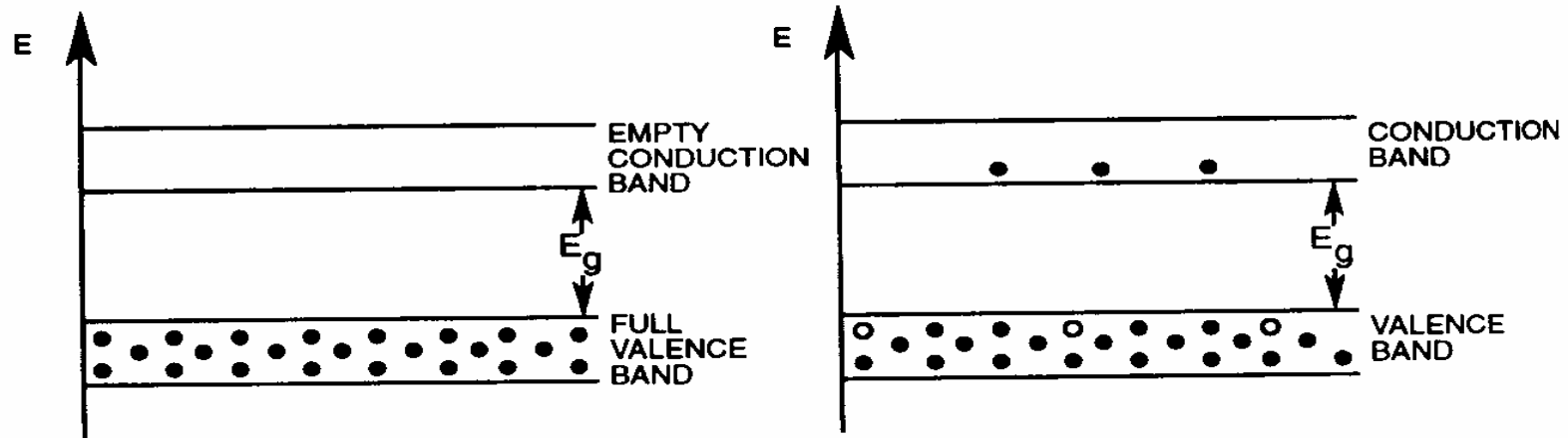
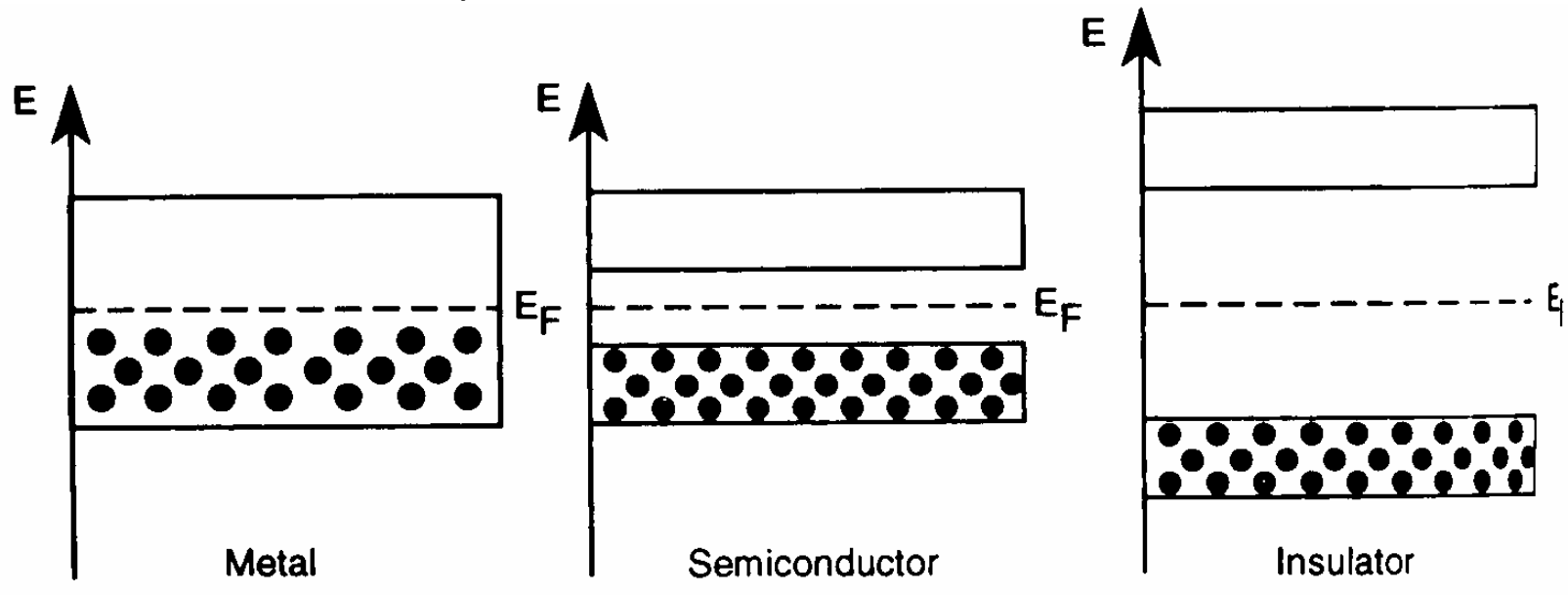

FIG. 18.29 Energy levels in sodium: (a) isolated atoms; (b) section of crystal. The sharp levels in the atom have become bands in the crystal.

# 能帶



# 能帶



Intrinsic semiconductor  
at 0 K

Intrinsic semiconductor  
at 300 K.  
Some electrons have

# 原子的軌域及能帶結構

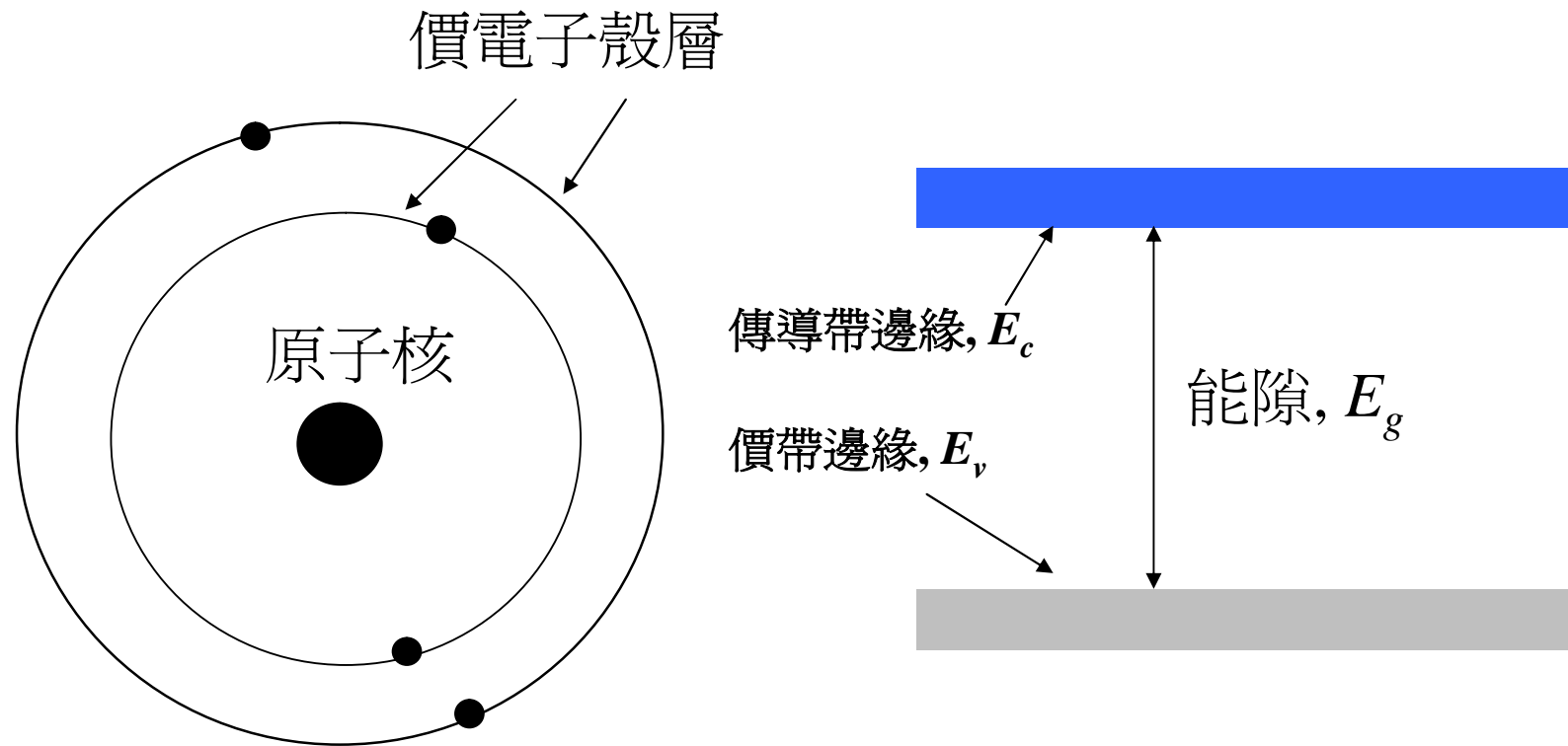

# 能隙及電阻率

