

Fall 2019

微分方程 Differential Equations

Unit 07.4 Operational Properties II

$$\mathcal{L}\{t^n f(t)\}$$

$$\mathcal{L}\{f(t) * g(t)\}$$

$$\mathcal{L}\{f(t + T)\}$$

Feng-Li Lian

NTU-EE

Sep19 – Jan20

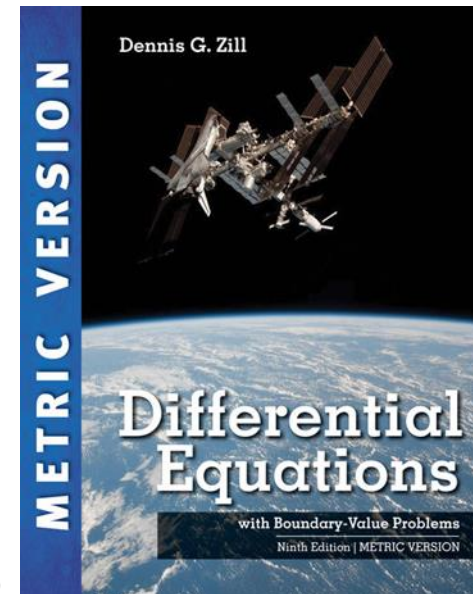

- 7.1: Definition of Laplace Transform
- 7.2: Inverse Transforms and Transforms of Derivatives
 - 7.2.1: Inverse Transforms
 - 7.2.2: Transforms of Derivatives
- 7.3: Operational Properties I
 - 7.3.1: Translation on the s-Axis
 - 7.3.2: Translation on the t-Axis
- **7.4: Operational Properties II**
 - **7.4.1: Derivatives of a Transform**
 - **7.4.2: Transforms of Integrals**
 - **7.4.3: Transform of a Periodic Function**
- 7.5: The Dirac Delta Function
- 7.6: Systems of Linear Differential Equations

7.4.1: Derivatives of a Transform: Multiplication

- Theorem 7.4.1: Derivatives of Transforms

IF $\mathcal{L}\{f(t)\} = F(s)$

THEN $\mathcal{L}\{f(t)\} = F(s)$

- Proof:

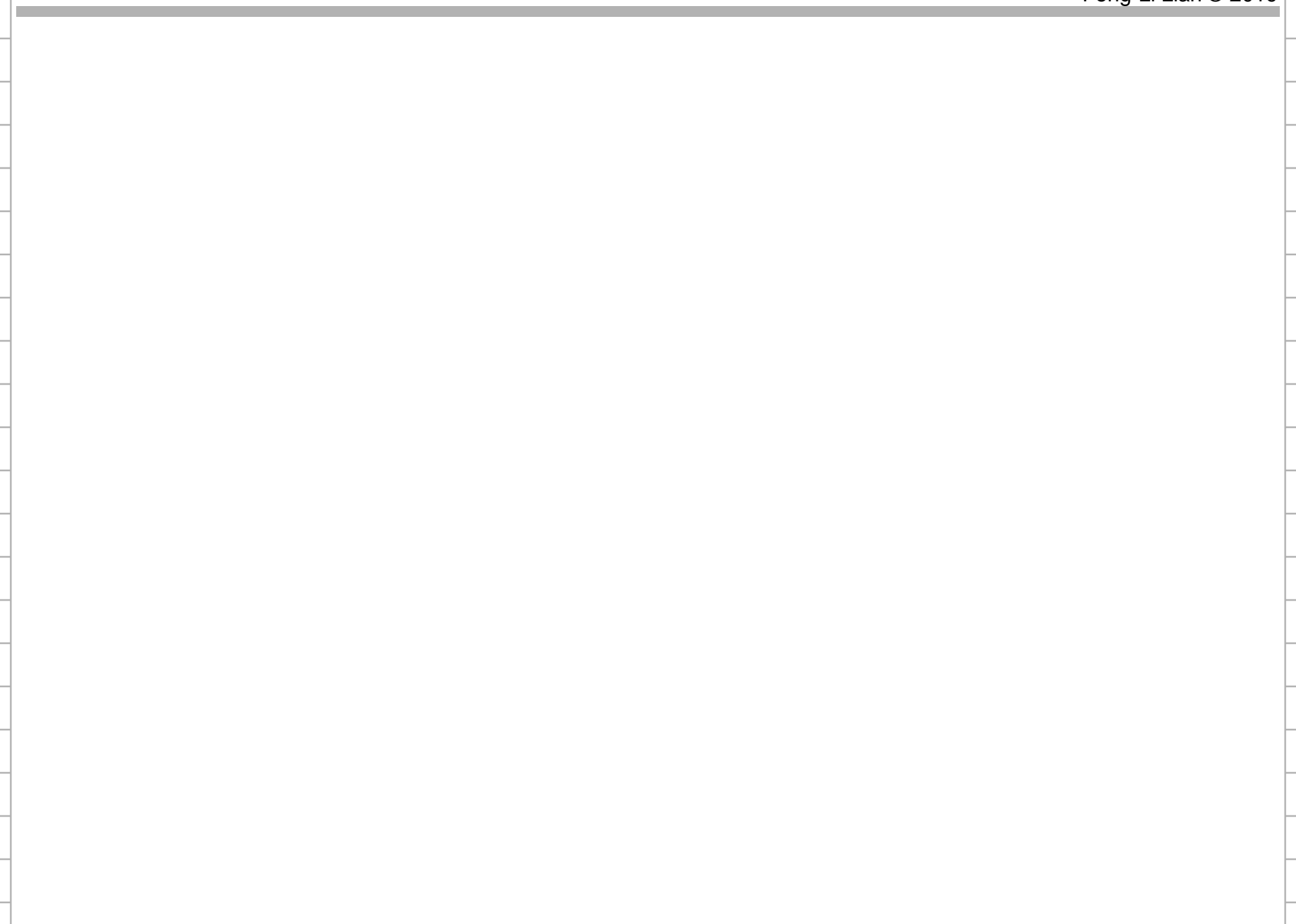

$$\mathcal{L} \left\{ t e^{-t} \cos t \right\} =$$

- method 1

$$\mathcal{L} \left\{ \cos t \right\} =$$

$$\mathcal{L} \left\{ e^{-t} \cos t \right\} =$$

$$\mathcal{L} \left\{ t e^{-t} \cos t \right\} =$$

$$\mathcal{L} \left\{ t e^{-t} \cos t \right\} =$$

- method 2

$$\mathcal{L} \left\{ \cos t \right\} =$$

$$\mathcal{L} \left\{ t \cos t \right\} =$$

$$\mathcal{L} \left\{ e^{-t} t \cos t \right\} =$$

- $f(t)$ and $g(t)$:

$$\Rightarrow f(t) * g(t) =$$

$$\begin{aligned} f(t) * g(t) &= \int_0^t f(\tau) g(t-\tau) d\tau = h(t) \\ &= \int_0^t f(t-\tau) g(\tau) d\tau \end{aligned}$$

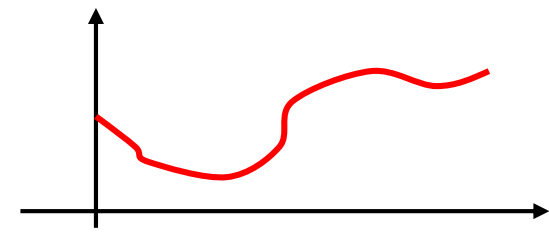
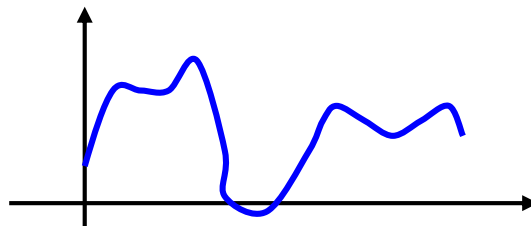
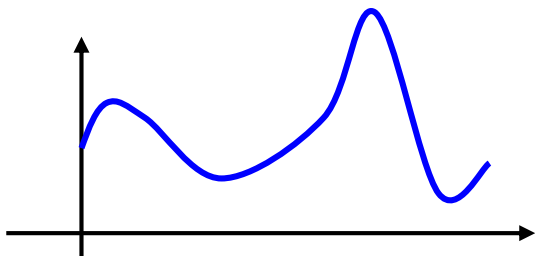

- Theorem 7.4.2: Convolution Theorem

IF $f(t)$ and $g(t)$:

THEN $\mathcal{L}\{f(t) * g(t)\} =$

- Proof:

- $f(t) * \mathcal{U}(t) = ?$

$$f(t) \xleftrightarrow{\mathcal{L}} F(s)$$

$$\frac{d}{dt} f(t) \xleftrightarrow{\mathcal{L}}$$

$$\frac{d^n}{dt^n} f(t) \xleftrightarrow{\mathcal{L}}$$

$$\int_0^t f(\tau) d\tau \xleftrightarrow{\mathcal{L}}$$

$$\int_0^t \left(\int_0^{\tau_{n-1}} \left(\cdots \left(\int_0^{\tau_1} f(\tau) d\tau \right) d\tau_1 \right) \cdots \right) d\tau_{n-1} \xleftrightarrow{\mathcal{L}}$$

$$-t f(t) \xleftrightarrow{\mathcal{L}}$$

$$t^2 f(t) \xleftrightarrow{\mathcal{L}}$$

$$(-1)^n t^n f(t) \xleftrightarrow{\mathcal{L}}$$

- Definition: Periodic Function

$f(t)$ is a **periodic** function with a period $T > 0$

if $f(t + T) =$

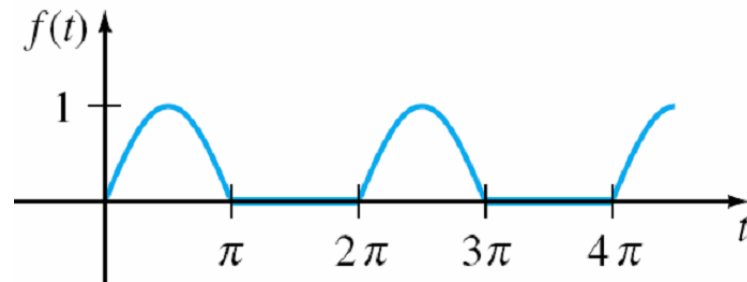

half-wave rectification of $\sin t$

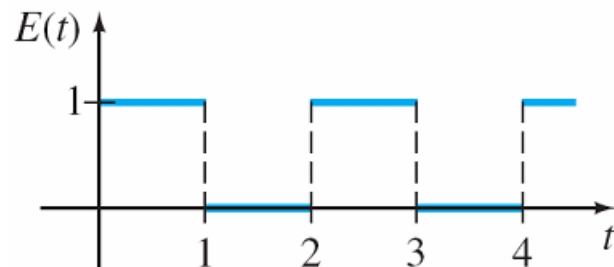

square wave

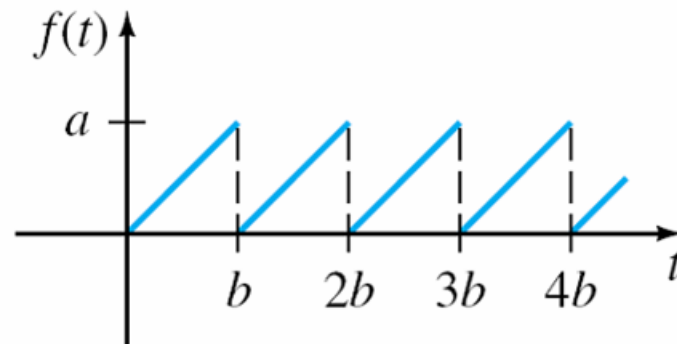

sawtooth

- Theorem 7.4.3:

$$\text{IF } f(t) : \left\{ \begin{array}{l} (1) \\ (2) \\ (3) \end{array} \right.$$

$$\text{THEN } \mathcal{L}\{f(t)\} =$$

- **Proof:**

$$F(s) = \mathcal{L}\{f(t)\} =$$

7.4.3: Transform of a Periodic Function

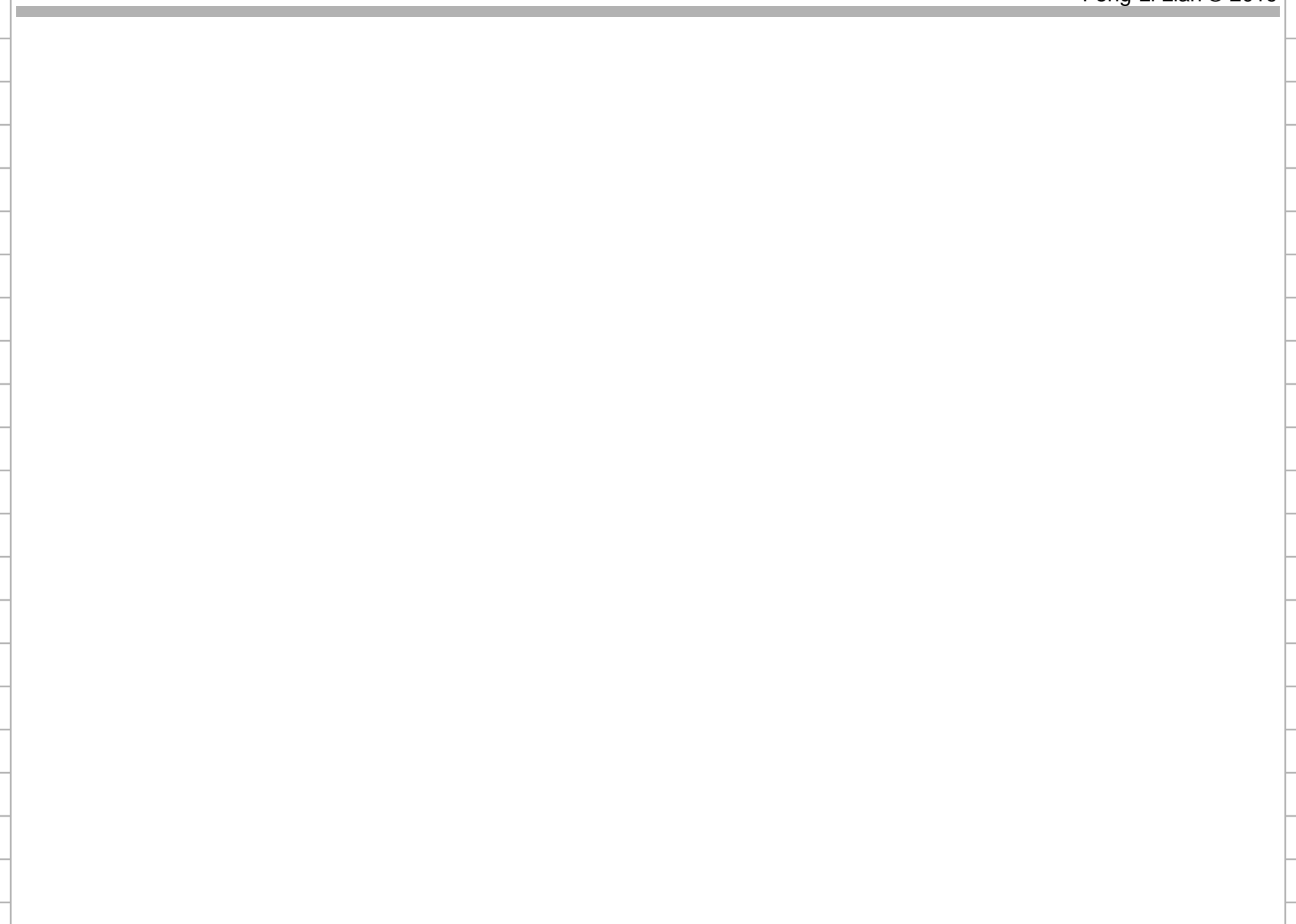

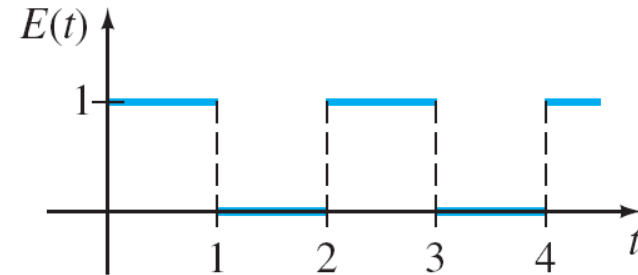
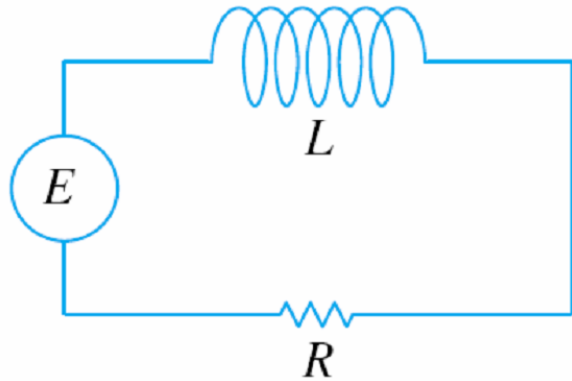

$$L \frac{d}{dt} i(t) + R i(t) = E(t) \quad i(0) = 0$$

$$\Rightarrow L s I(s) +$$

$$\Rightarrow \mathcal{L} \{ E(t) \} =$$

7.4.3: Examples 8 & 9

- IF $R = 1$, $L = 1$, $0 \leq t < 4$

$$i(t) = \begin{cases} 1 - e^{-(t)}, & 0 \leq t < 1 \\ -e^{-(t)} + e^{-(t-1)}, & 1 \leq t < 2 \\ 1 - e^{-(t)} + e^{-(t-1)} - e^{-(t-2)}, & 2 \leq t < 3 \\ -e^{-(t)} + e^{-(t-1)} - e^{-(t-2)} + e^{-(t-3)}, & 3 \leq t < 4 \end{cases}$$

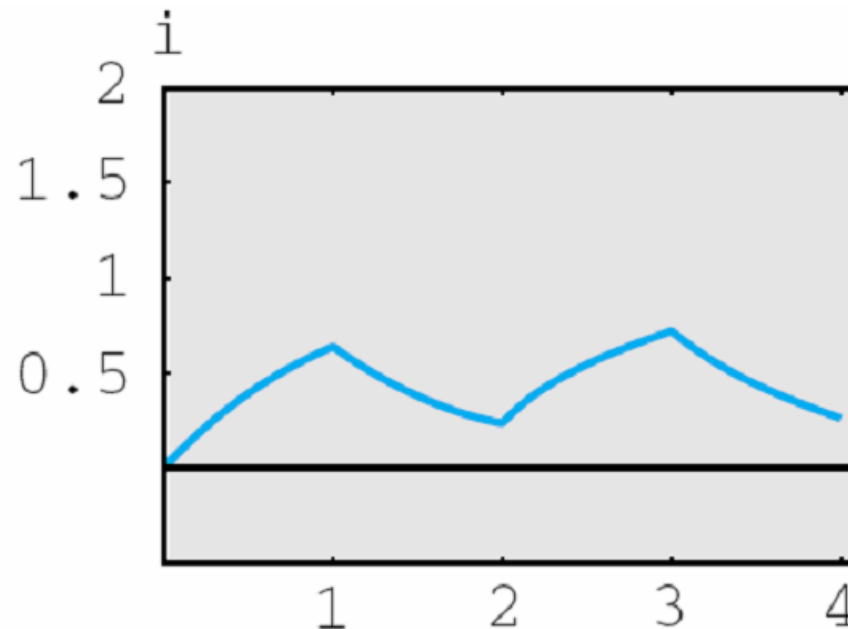

$$\mathcal{L}\{f(t)\} \triangleq \int_0^{\infty} e^{-st} f(t) dt = F(s)$$

$$\mathcal{L}\{f(t)\} = F(s)$$

$$\mathcal{L}\{t^n f(t)\} = (-1)^n \frac{d^n}{ds^n} F(s)$$

$$\mathcal{L}\{f(t) * g(t)\} = \mathcal{L}\{f(t)\} \mathcal{L}\{g(t)\} = F(s) G(s)$$

$$f(t + T) = f(t)$$

$$\mathcal{L}\{f(t)\} = \frac{1}{1 - e^{sT}} \int_0^T e^{-st} f(t) dt$$