

Confocal Microscopy & Time-lapse Video Recording IVIS Spectrum

錢宗良 (x88193)

臺灣大學醫學院

解剖學暨細胞生物學研究所

Leica TCS SP2/MP2: System Optics Overview



LEICA TCS SP5



Why confocal microscopy ?

- **Optical sectioning:**
Specimen is monitored slice by slice (3D-resolution)
Each slice produces a sharp image by confocal optics
- **Improved resolution power (PSF) :**
lateral resolution improved
Real axial resolution power
- **Improved contrast:**
Rasterizing the specimen, stray light due to scattering is suppressed
- **Multi-dimensional acquisition with digital image processing**
 $X-Y-Z-T-I-\theta-\lambda$
- **New application, FRAP, FLIM, FRET, Cage, Bio-Mapping**

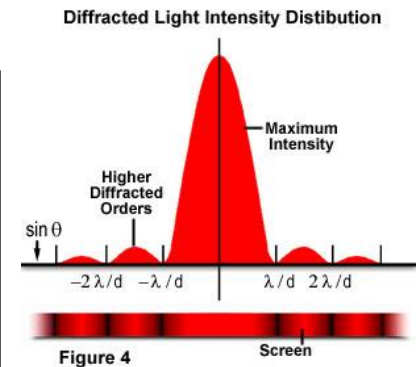
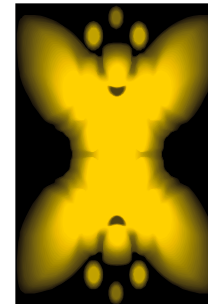

Principle of Confocal

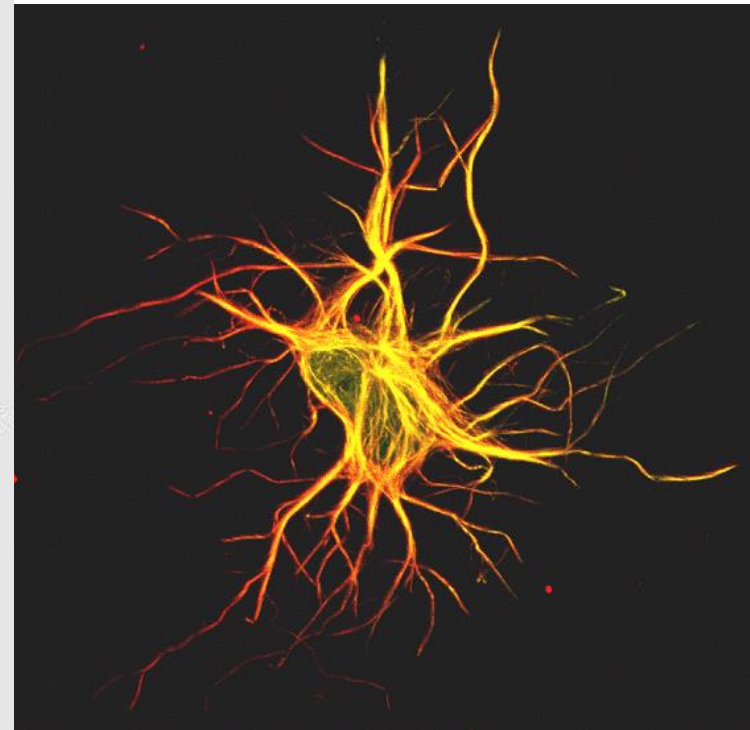
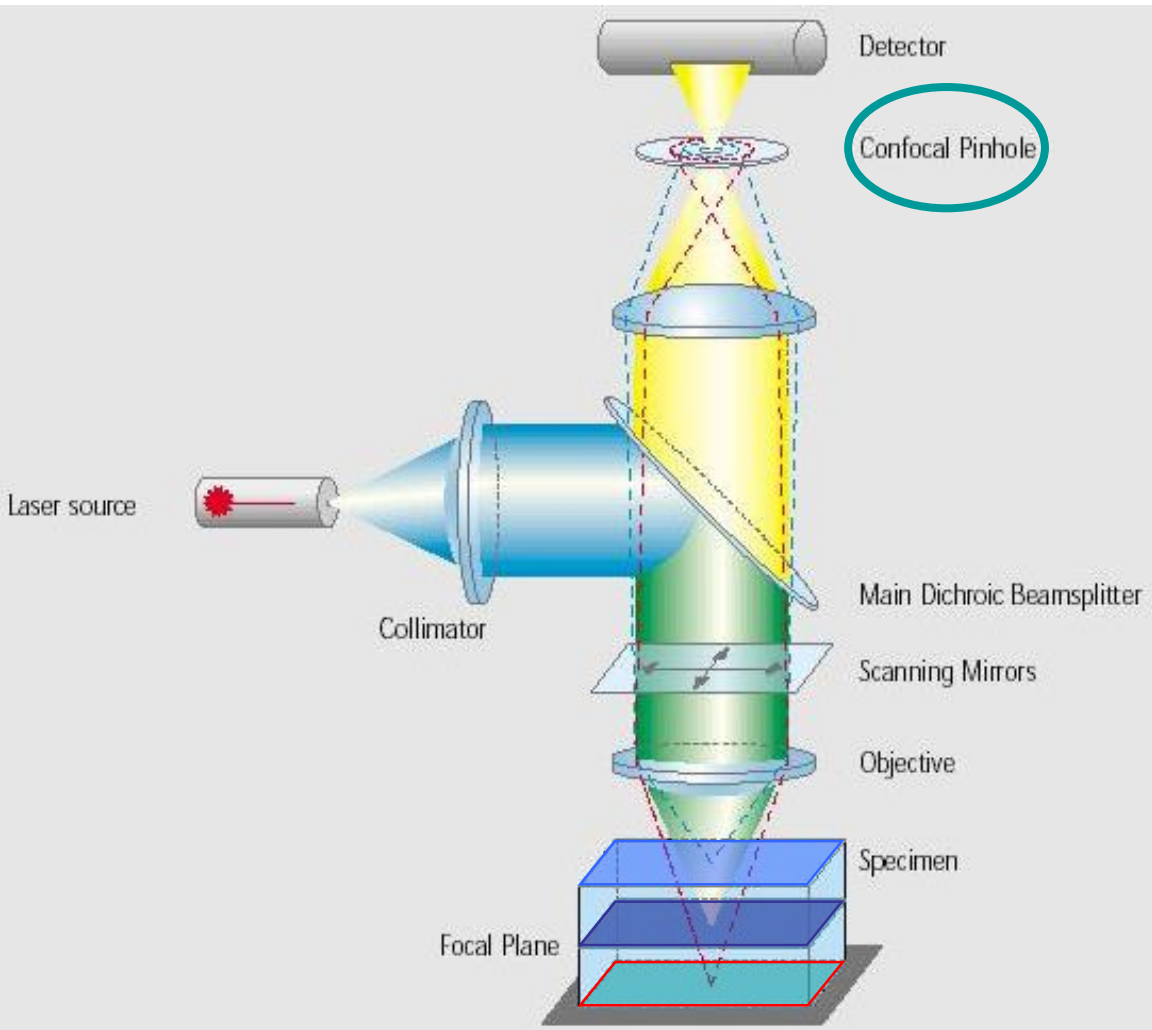

Leica TCS SP2/MP2: System Optics Overview

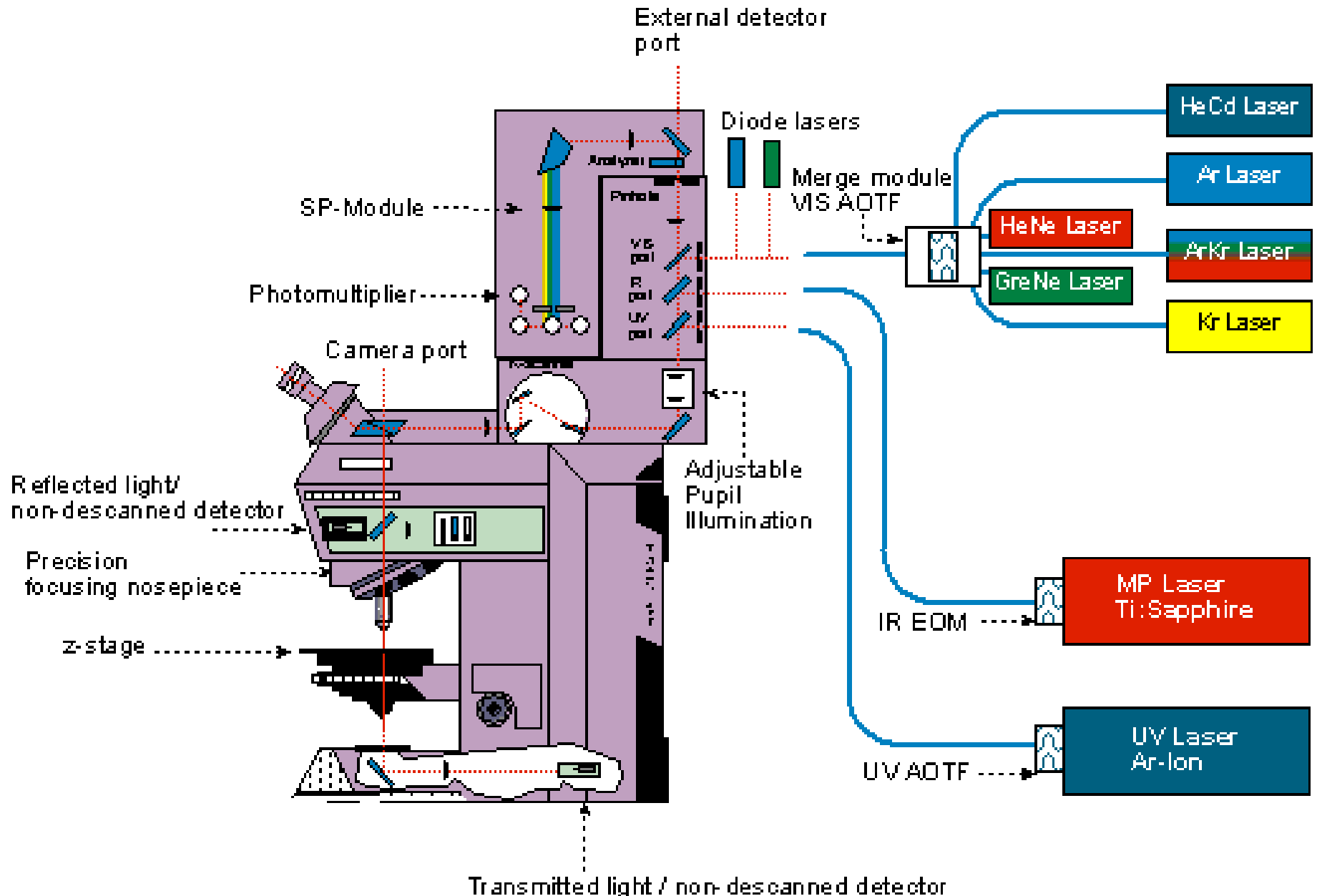

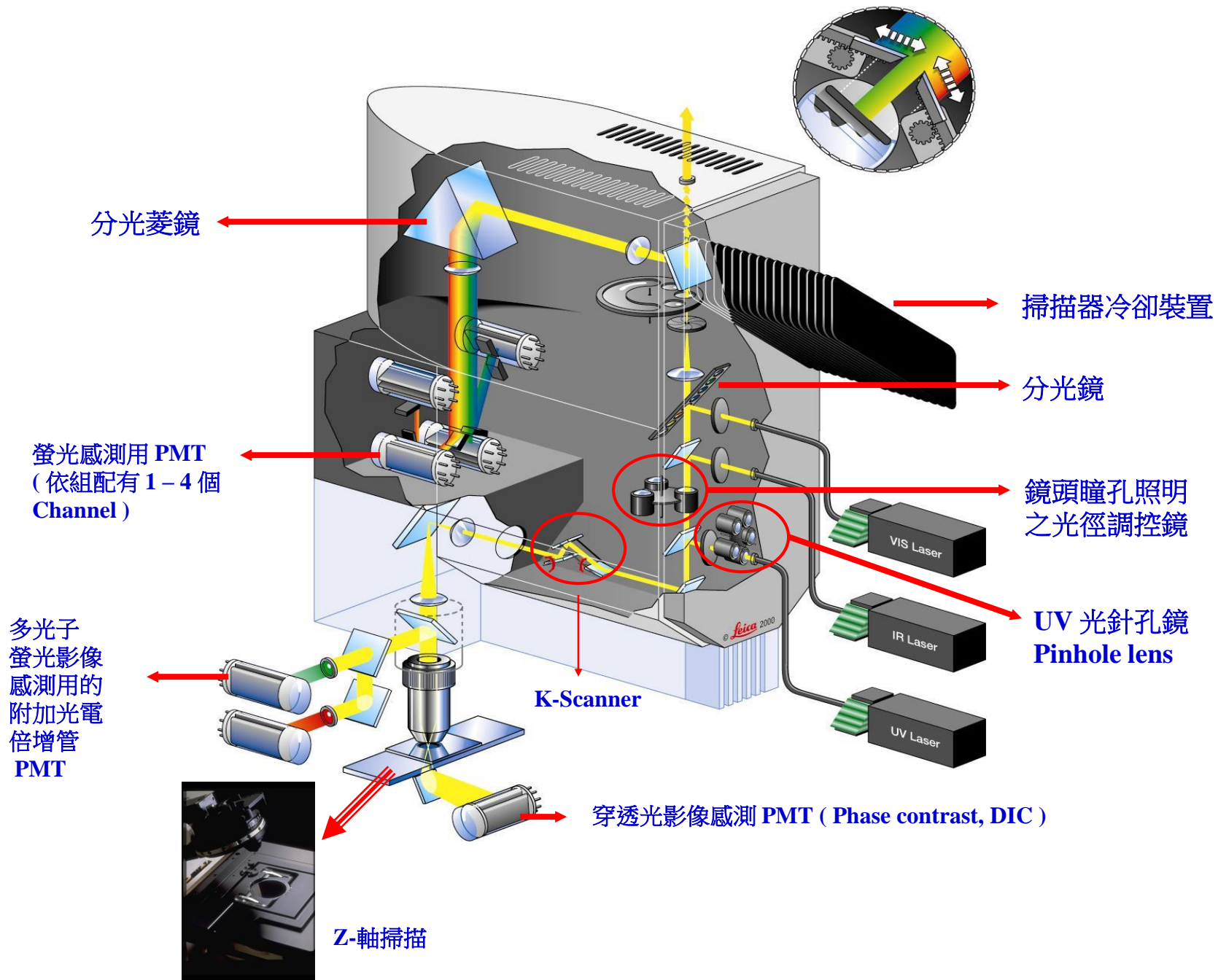

Confocal Spectral Microscope Leica TCS SP5

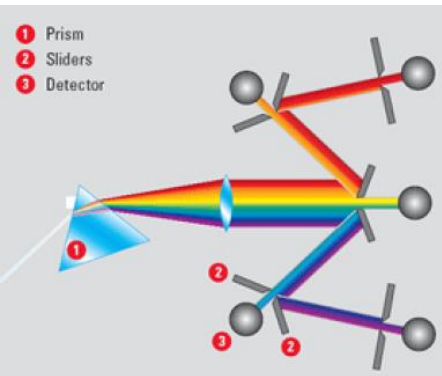
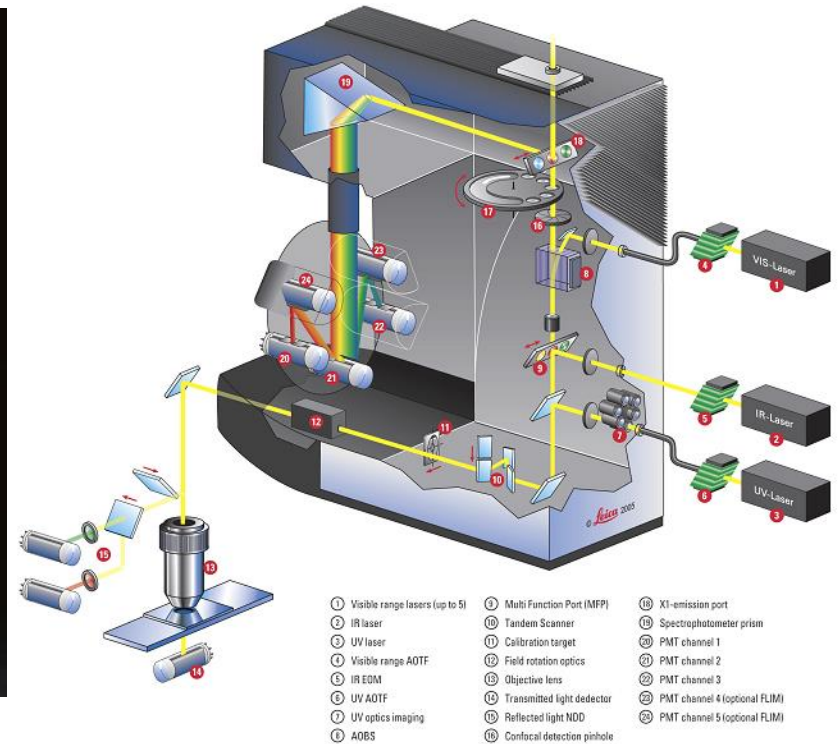

AOTF	<p>標準可程式光波調控 (AOTF, Acousto Optical Tunable Filter, programmable), 包括紫外光雷射 (UV 3 channels - 選配), 可見光雷射 (VIS 8 channels), 紅外光雷射 (EOM), 皆採用 AOTF (EOM IR - 選配) 調控雷射光波選取與強度控制。可精確控制光波強度, 避免螢光漂白。達到最佳多重螢光染劑的激發效果。</p>
AOBS	<p>選配 Leica 獨家專利可程式分光控制, 可同時分光調控 8 channels. 任何螢光的激發光譜與釋放光譜, 皆可精確的分光, 解析可低於 2 nm 寬幅。使用人員可廣泛使用染劑組合, 使用 AOBS 可將螢光訊號重疊 (Crosstalk) 降到最低., 提升螢光偵測訊號, 大幅提高螢光影像的解析。</p>

Confocal Spectral Microscope Leica TCS SP5

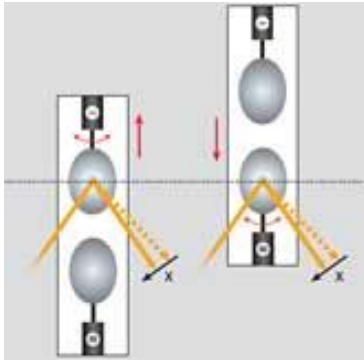

Tandem Scanner 在同一個掃描器，可切換使用兩組的掃描器，完全微電腦控制。

C Scanner 提供超高光學解晰的影像擷取 **Ultra High resolution image acquisition.**

R Scanner 提供超高速的影像擷取 **Ultra-Low Photobleaching image acquisition.**

Conventional Scanner (C)		ResonantScanner (R)	
Max. line frequency	2800 Hz	Max. line frequency	16000 Hz
Min. line frequency	1 Hz	Min. line frequency	8000 Hz
Scan speed granulation	1400	Scan speed granulation	1
Max. frame rate 512 x 512	5 Hz	Max. frame rate 512 x 512	25 Hz
Max. frame rate 512 x 16	25 Hz	Max. frame rate 512 x 16	250 Hz
Beam park	Yes	Beam park	No
Max. frame resolution	8192 x 8192 pixels	Max. frame resolution	1024 x 1024 pixels
Scan zoom	1.0x - 32x	Scan zoom	1.7x - 32x
Panning	Yes	Panning	Yes
Field rotation	200° optical	Field rotation	200° optical
Field diameter	21.2 mm	Field diameter	14.8 mm
超高解析掃描 - 多重螢光影像擷取 (Multi-spectral image acquisition)		超高速掃描掃描器 - 多重動態螢光影像擷取 (Multi-spectral image acquisition)	

Mode : Scanning and Image Capture

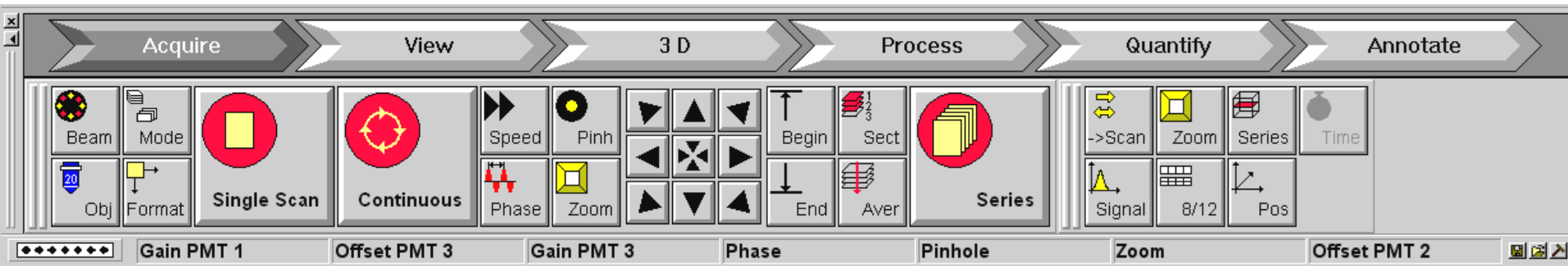

Mode	Functions
xyz	An image stack is recorded from xy-sections in z-direction. (3D)
xzy	An image stack is recorded from xz-sections in y-direction.
xt	A line is recorded several successive times.
xyt	An xy-section is recorded several successive times.
xzt	An xz-section is recorded several successive times.
xyzt	<u>An image stack is recorded from xy-sections in z-direction several successive times. (Example: drosomoitose)</u>
xyl	An xy-section is recorded at different wavelengths. (wavelength)
xzl	An xz-section is recorded at different wavelengths.

Frame-Mode xyt Configuration

Time-lapse vs. Real Time (movie)

- 64 * 64
- 100 * 100
- 200 * 200
- 512 * 32
- 512 * 512**
- 640 * 512
- 1024 * 1024

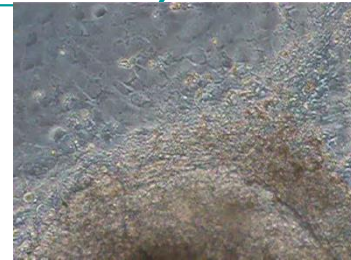

T Configuration

ΔT : 0 h 0 min 3 s 0 ms

Frames: 10

Complete Time: 0 h 0 min 27 s 0 ms

Reset Apply Close

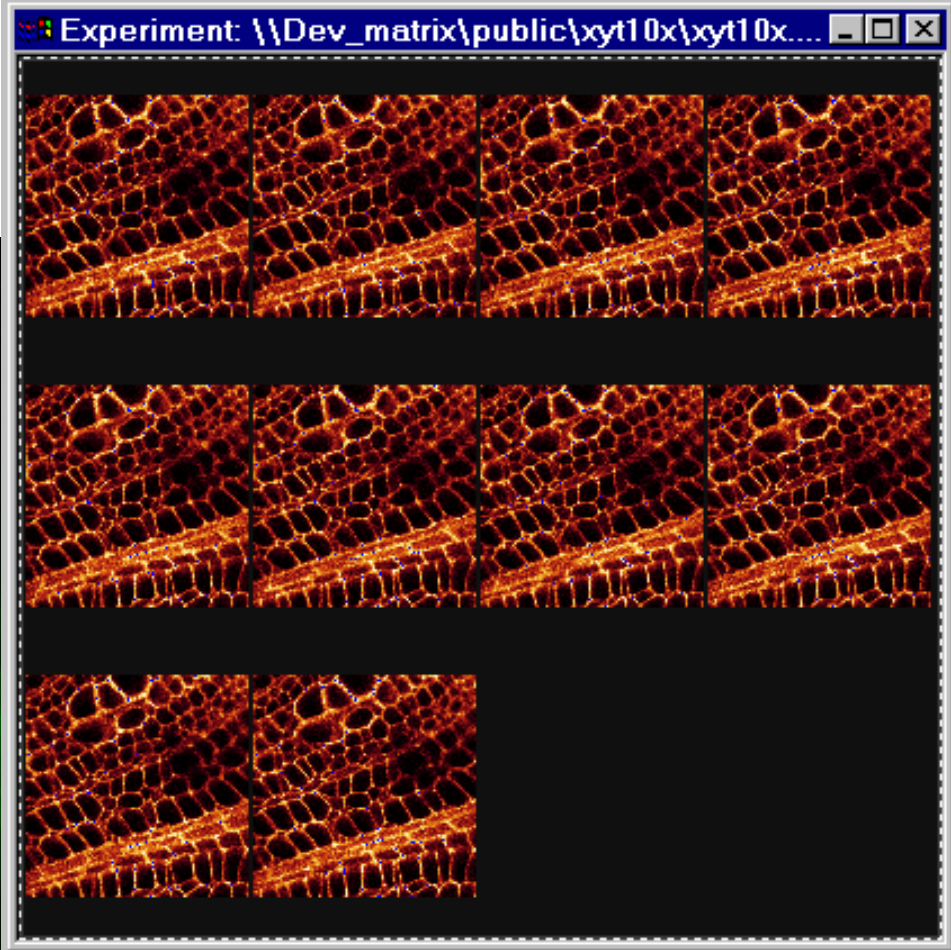
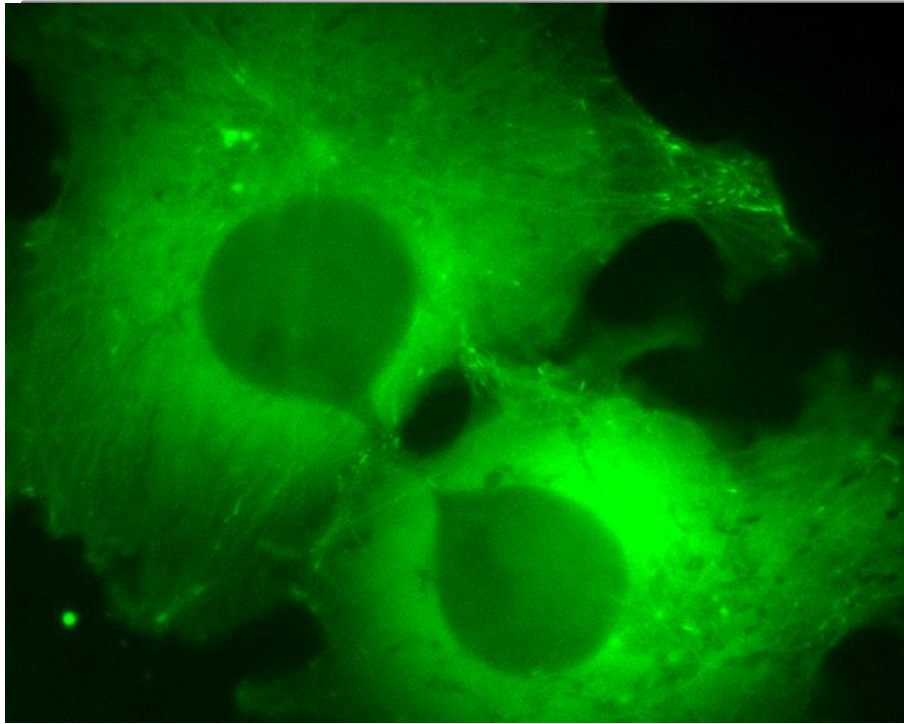

Stack-Mode Xyzt Configuration

Series Scan Overview

64 * 64
100 * 100
200 * 200
512 * 32
512 * 512
640 * 512
1024 * 1024
2048 * 2048
4096 * 4096

Mode: xyzt

Pos: -16.34 μm

Begin: 34.78 μm

End: -16.51 μm

Total: 51.29 μm

Begin

End

Close

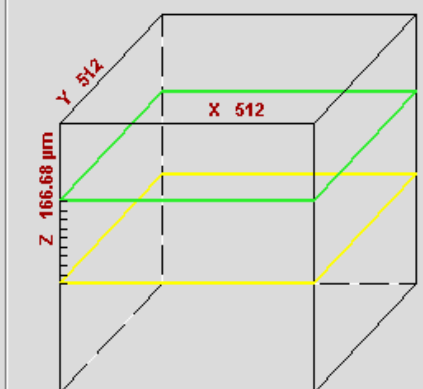

1
2
3
4
6
8
10
14
16
18
20
25
30
40
50

Others...
Close

T Configuration

ΔT : h min s ms

Stacks:

Complete Time: h min s ms

Reset Apply Close

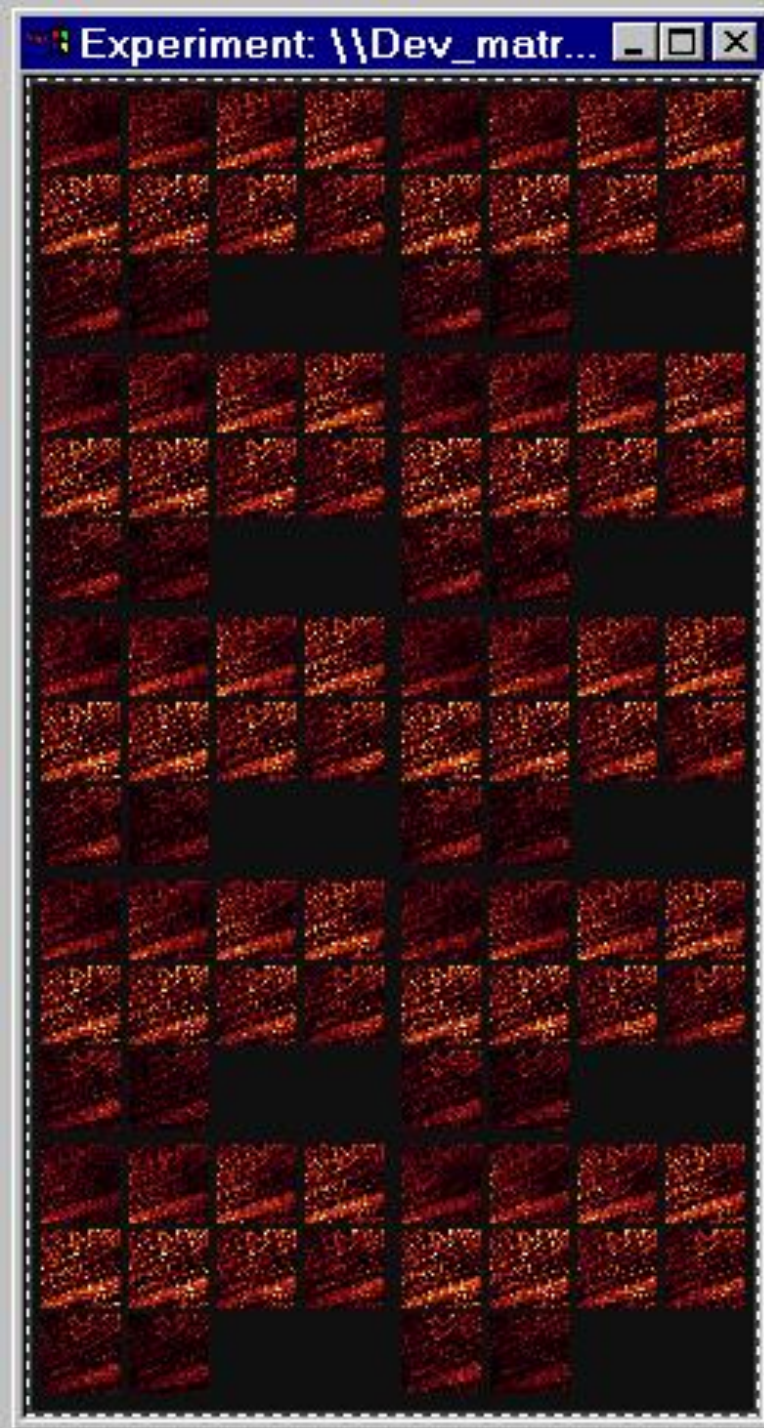

光電倍增器 Photomultiplier (PMT)

主要運用在分光譜後的共軛焦顯微鏡上共軛焦顯微鏡所使用的感測器是光電倍增器(PMT)所提供的感測器精密度達 0.1 nA , 俱有冷卻設計, 可除去暗電流 (Dark current), 提供超高解析。

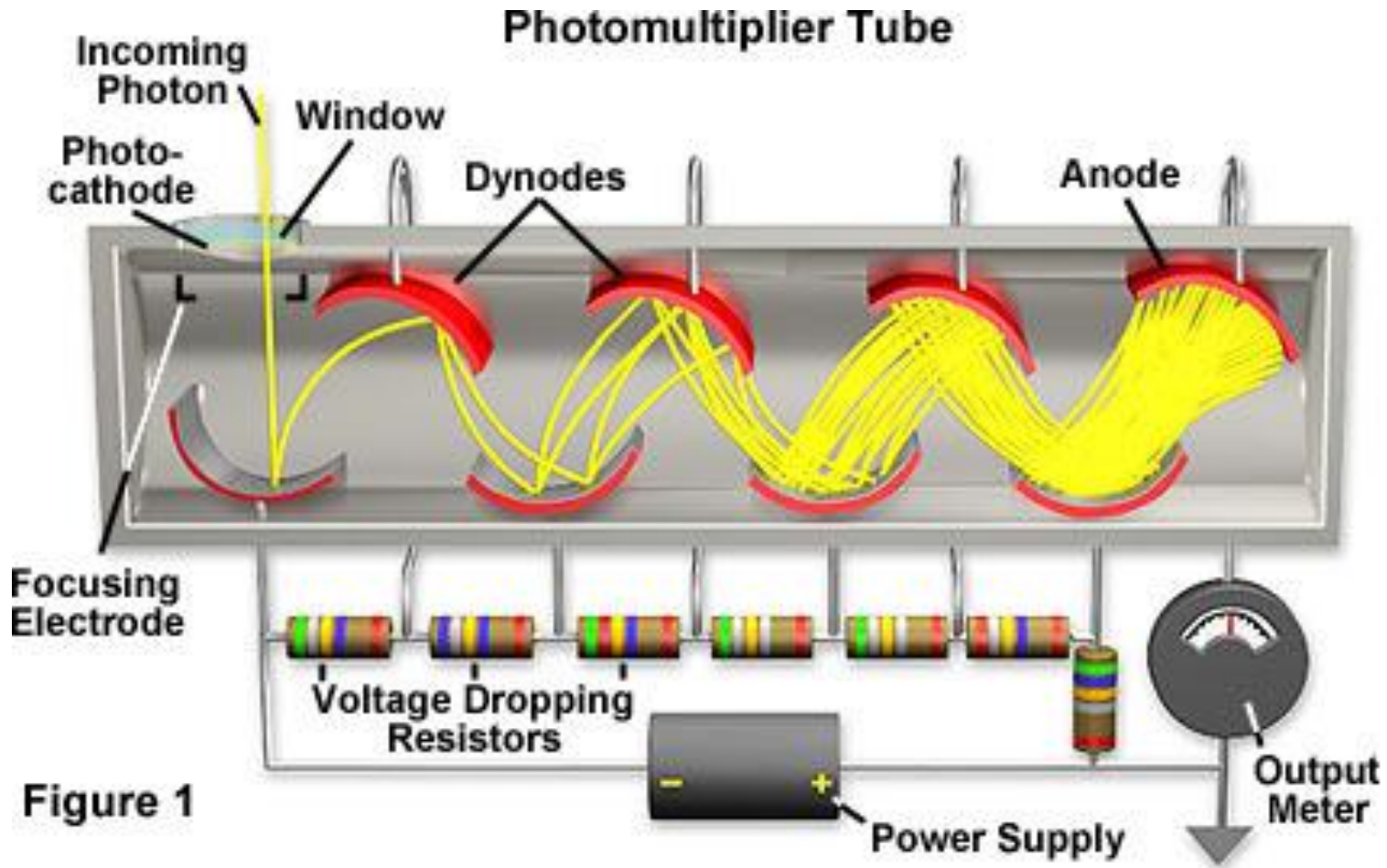

Spectral Base Detector

- Software Controller -

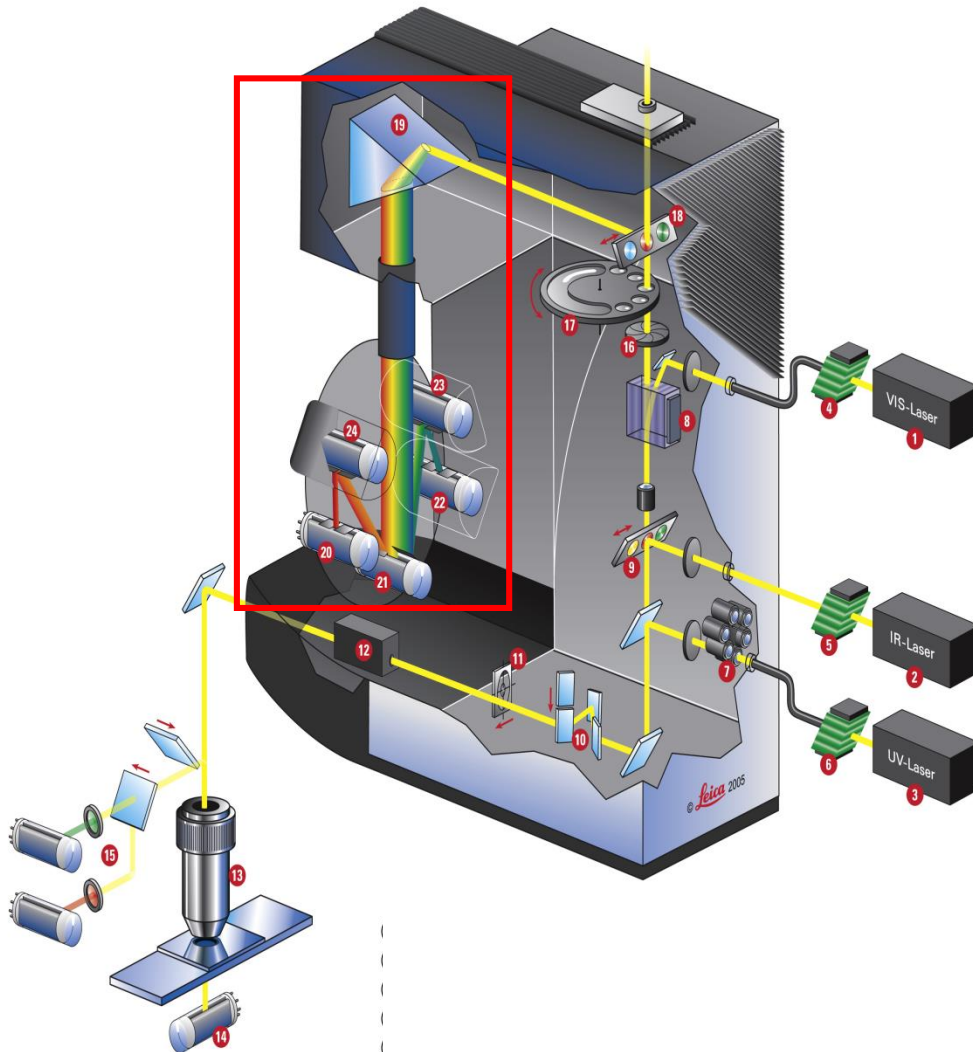

Spectral Based Detector

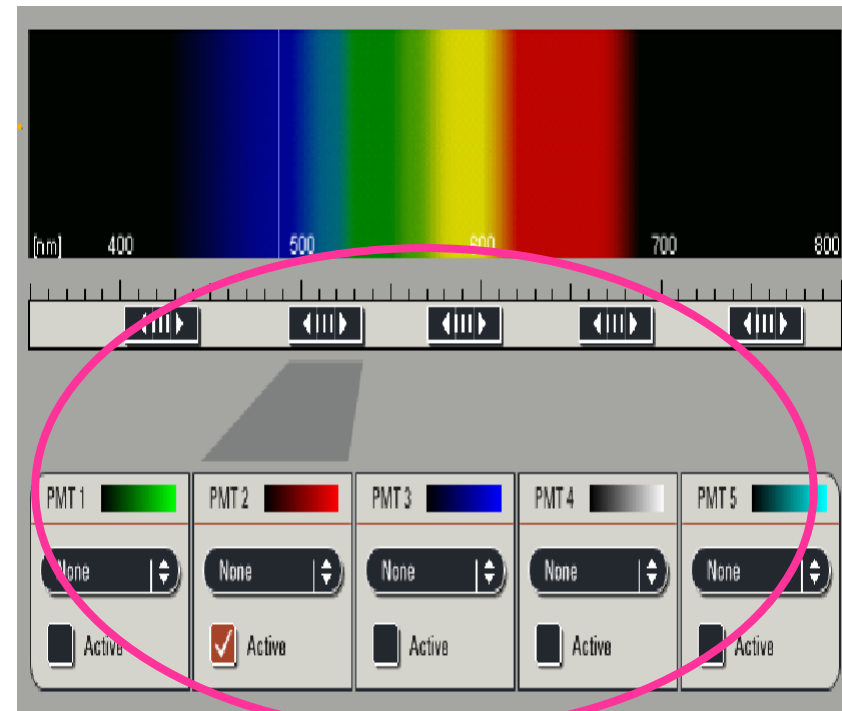

TCS SP/SP2: Prism Spectrophotometer Benefits

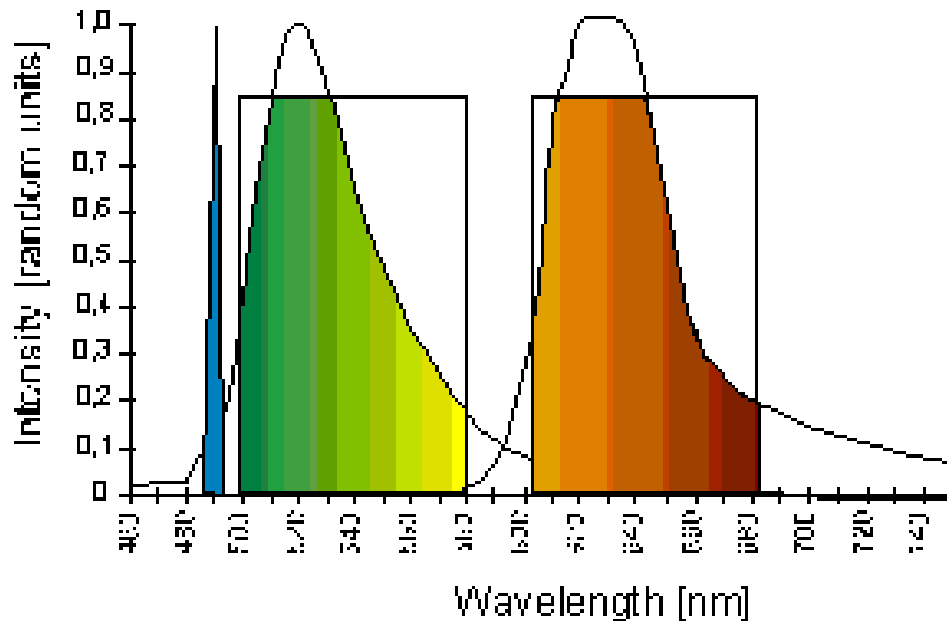

- Maximize efficiency
- Maximize flexibility
- Minimize crosstalk

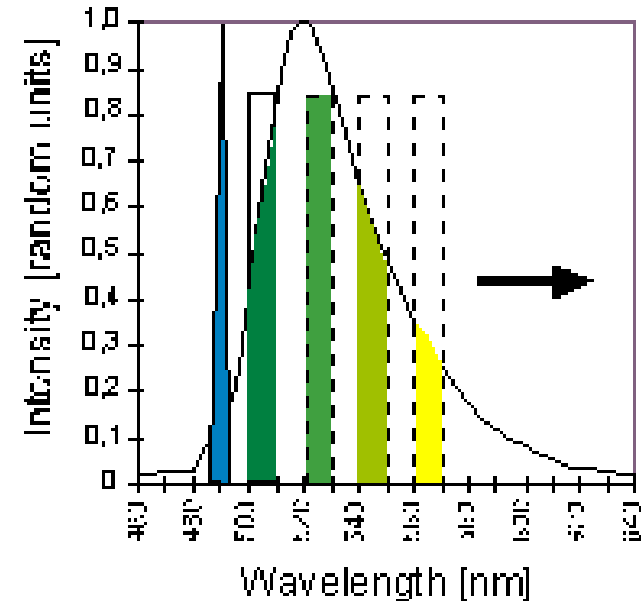

- Analyze the spectrum

ZEISS LSM 900 with Airyscan 2 Compact Confocal for Multiplex Imaging

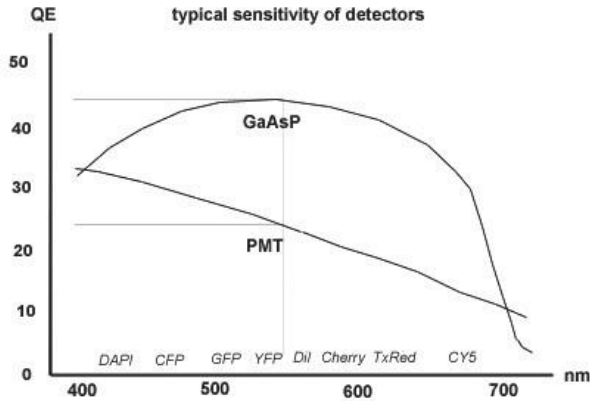

螢光感測器可以選擇傳統光電倍增管 (PMT)或是磷酸砷化鎵(GaAsP)感測器

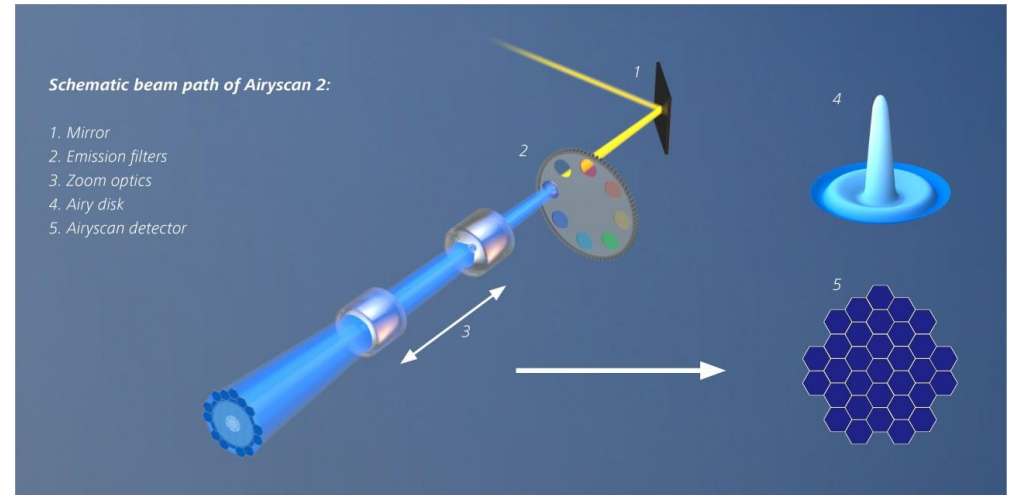

LSM900 同時支援Zeiss 最新技術 Airyscan 2 XYZ解析度同步提升2倍的超高解析技術

ZEISS LSM 900 with Airyscan 2 Compact Confocal for Multiplex Imaging

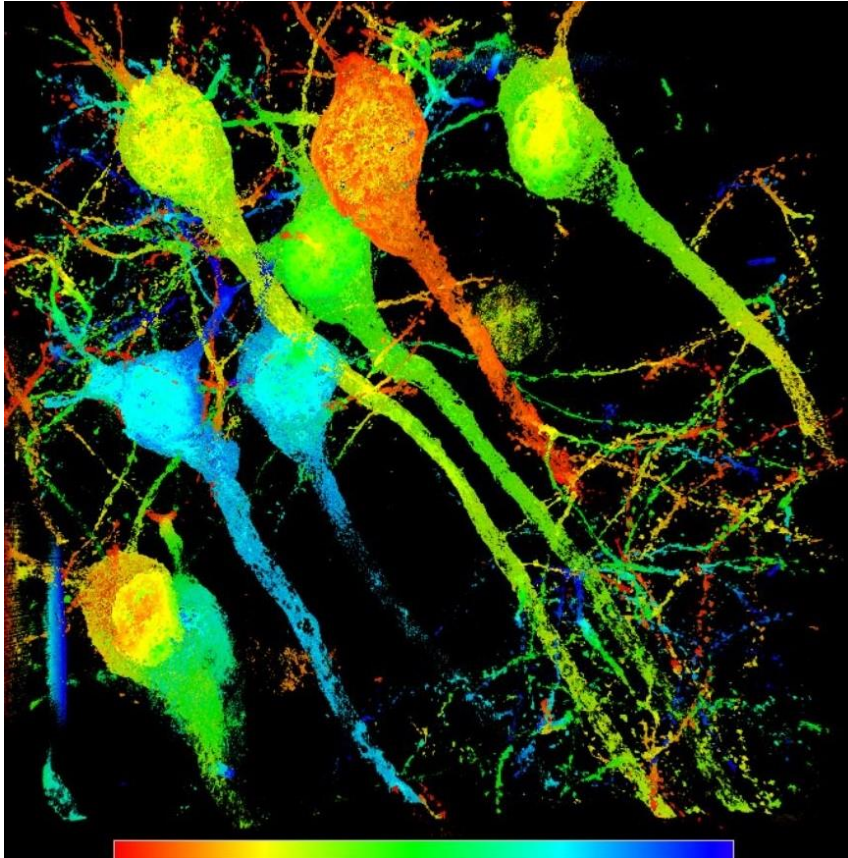

LSM 900 Neurons DepthCoded 3D,
Fluorescence

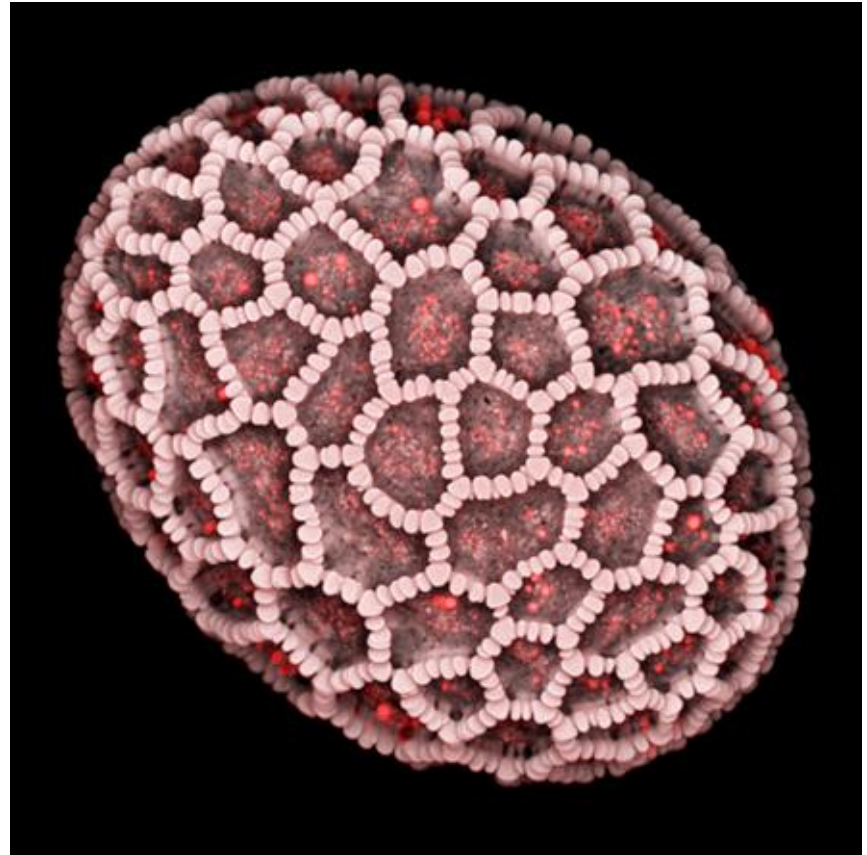

The micrograph shows a *Lilium auratum* pollen grain, acquired *with Airyscan 2* in Multiplex mode. Image courtesy of Jan Michels, Zoological Institute, Kiel University

***ZEISS LSM 900 with Airyscan 2
Compact Confocal for Multiplex
Imaging***

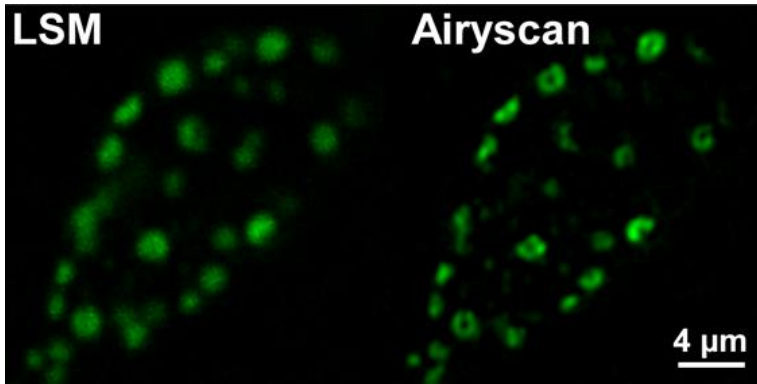

Drosophila brain, neuromuscular junction stained for Bruchpilot (BRP), comparison between confocal *LSM* and *Airyscan*.

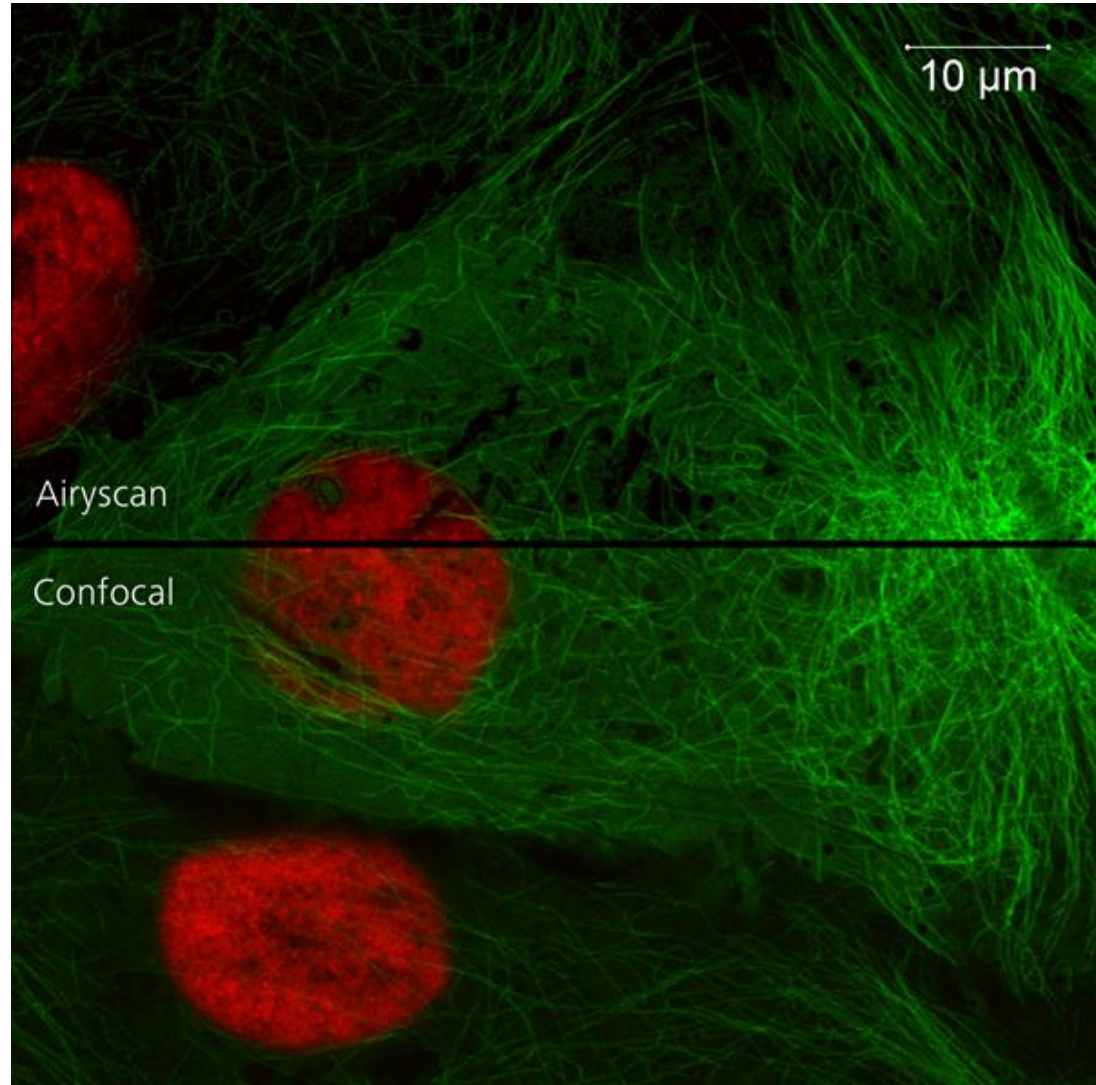

Living Pig Kidney Epithelial cells (LLC-PK1), green: Tubulin-eGFP, red: h2b-mCherry; Imaged with *ZEISS LSM 800 with Airyscan*, Plan-Apochromat 63x/1.4 Oil,

ZEISS LSM 900 with Airyscan 2 Compact Confocal for Multiplex Imaging

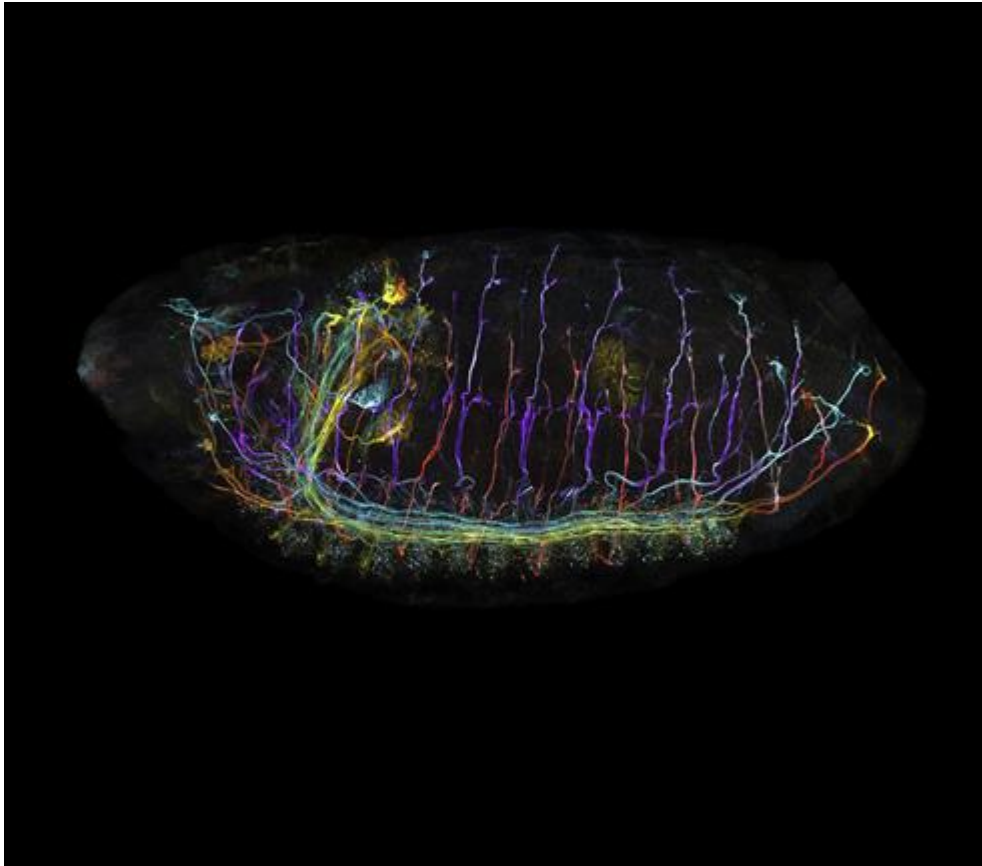

Drosophila ZEN Connect 1-01 *Airyscan*
Processing-01-Stitching-02-Color-coded
Projection-04-2

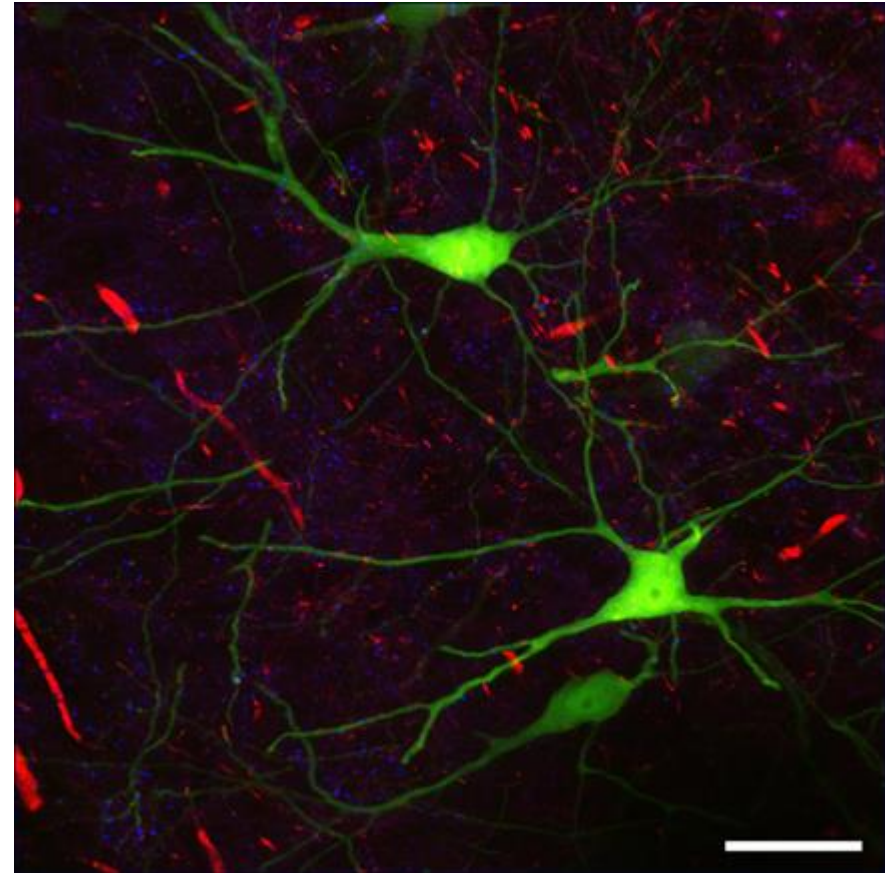

Mouse brain slice; EGFP-Thy1 (green): nerve cells (subset), Calretin-Cy3 (red): Calretinin-expressing neurons, GAD65-Cy5 (blue): GABAergic synapses. Scale bar 50 μ m.

Applification

xy Acquisition of a single frames

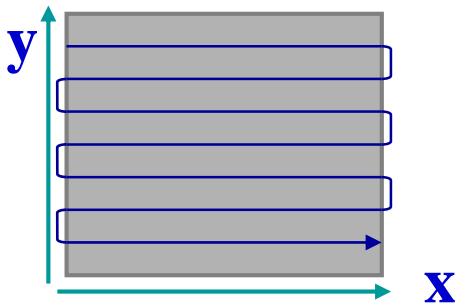
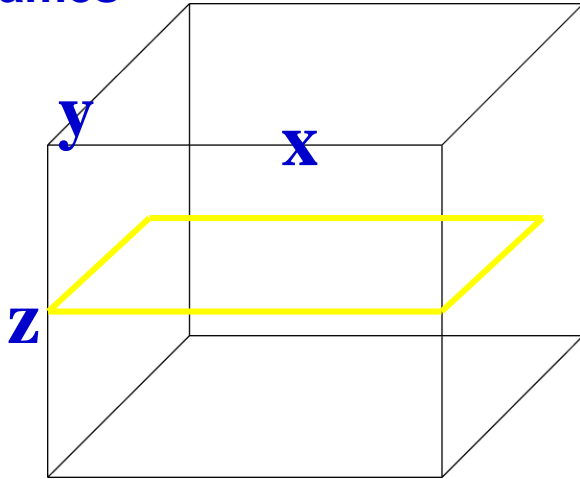

Drosophila leg,
FITC

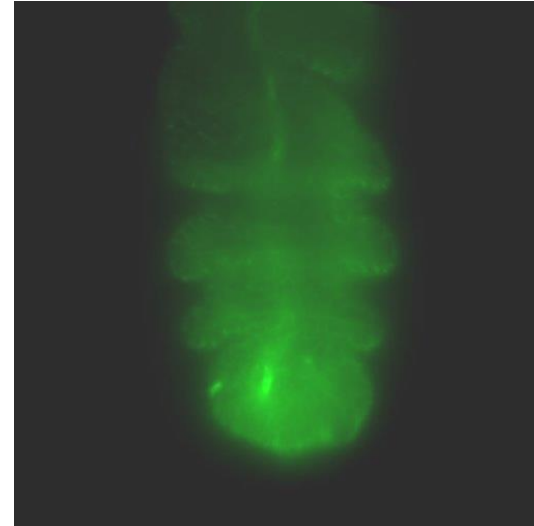

Non-confocal

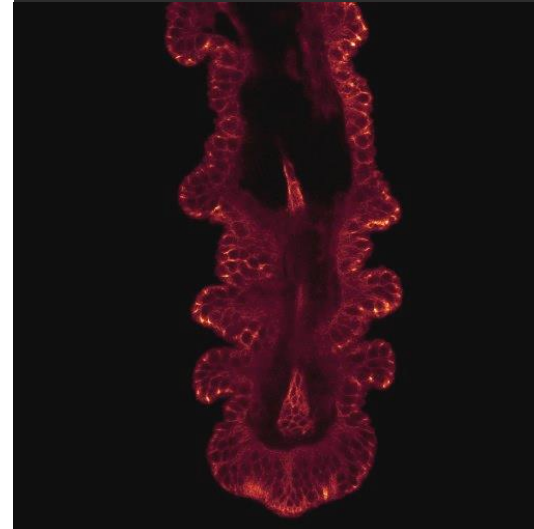

Confocal
3D-
structure

xyz projections: different algorithms

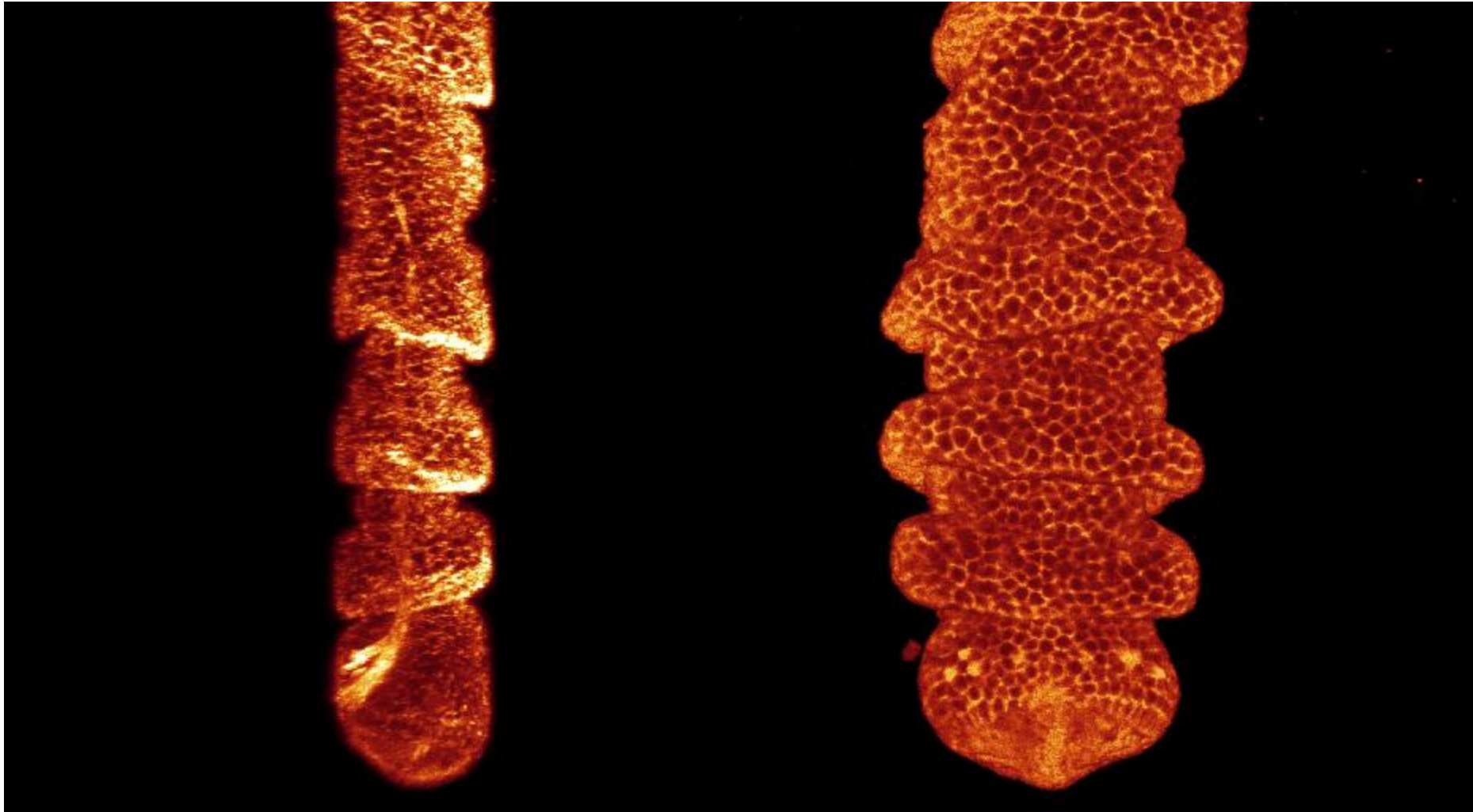

Drosophila leg, FITC, projection

Surface rendering

xy scanning

- Sample overview
- Colocalization studies
- Resolution-enhanced, high contrast images

Endothelial cells
— FITC (Actin)
— Mito-Tracker

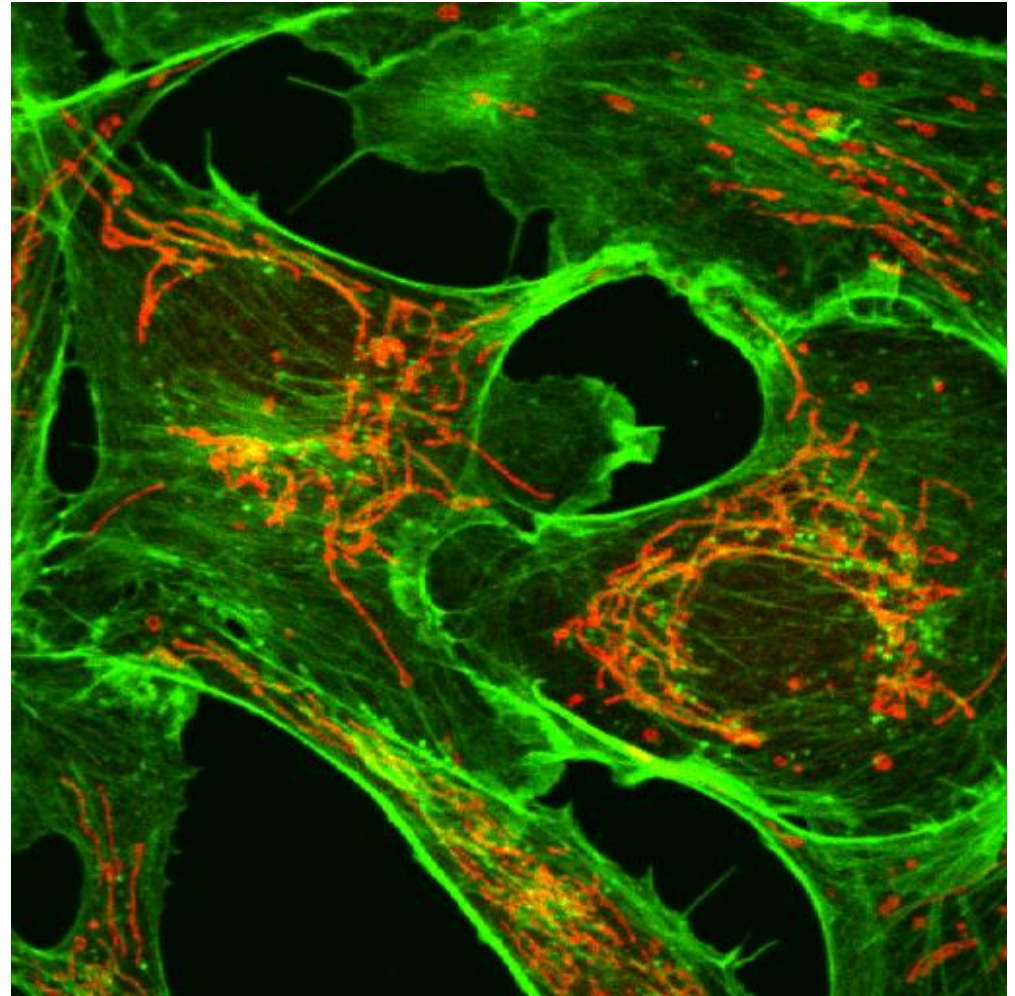

XZ

Beam is scanned in x-direction
Sample is moved in z (z-stage)

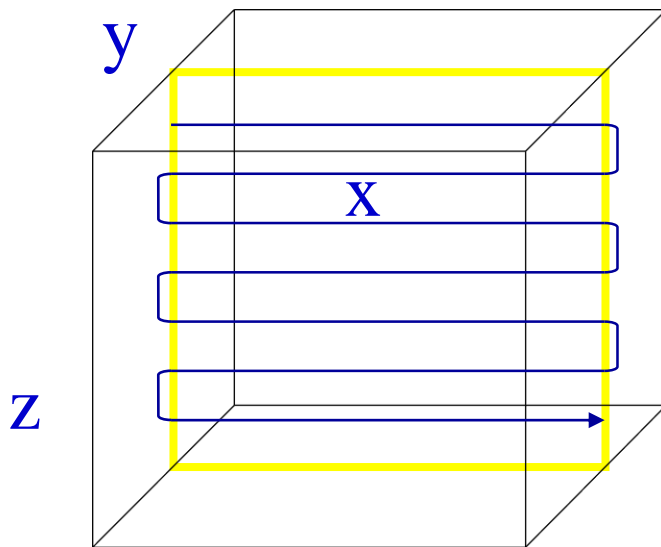

Z resolution depends on axial resolution
of objective, generally 2x less than in xy
xy: 180 nm, z: 360 nm

- Orientation of sample
- Spatial relations between structures in z
- Polarized cells

xz scanning

- Up to 20 frames per second with the Leica TCS SP2!

Convallaria

- Starch grain
- Cell wall

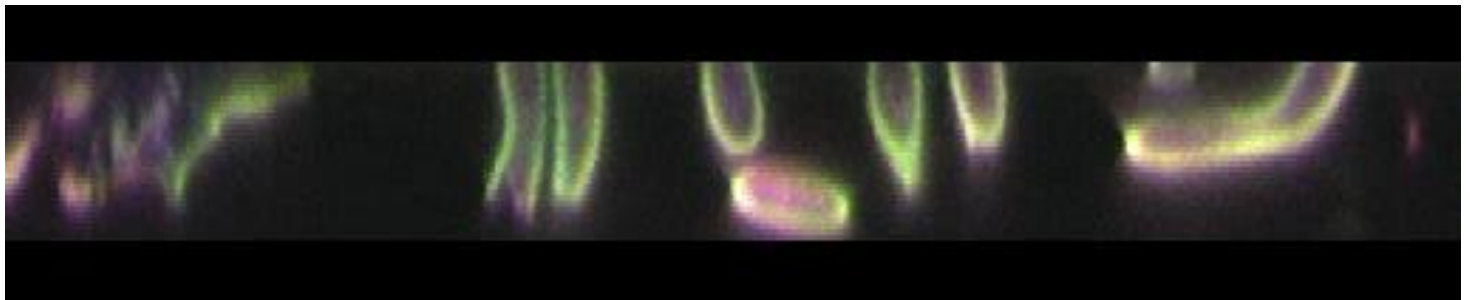
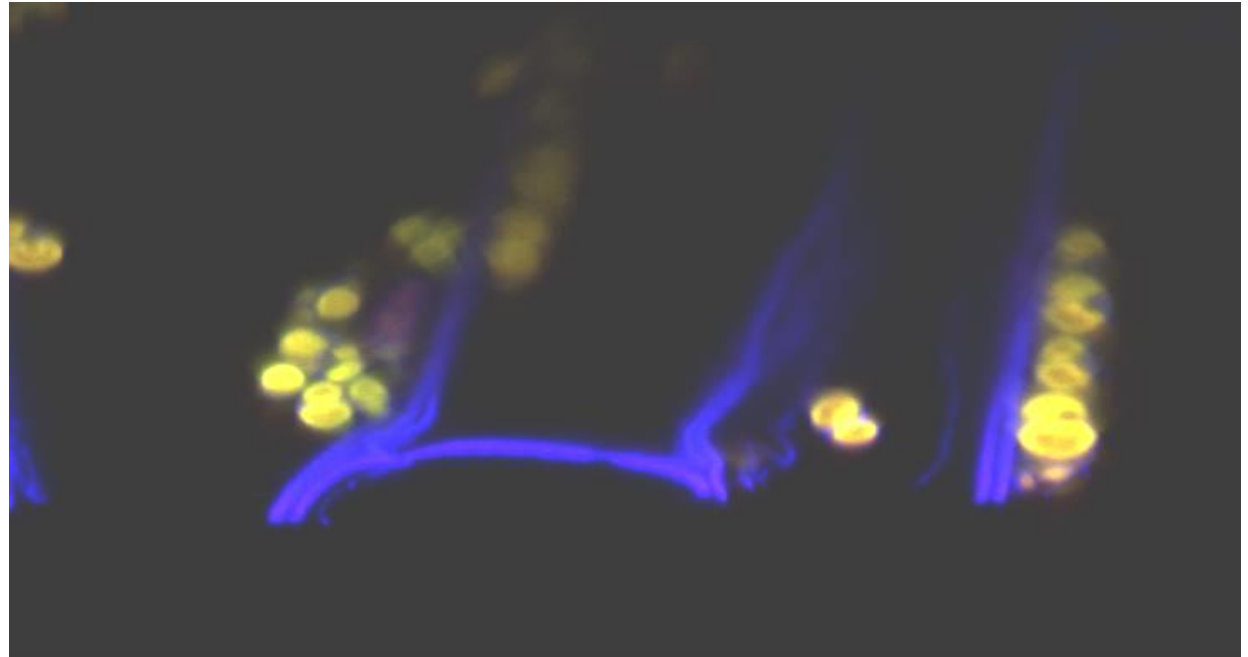

この像の緑のラインで横
部分の断層像

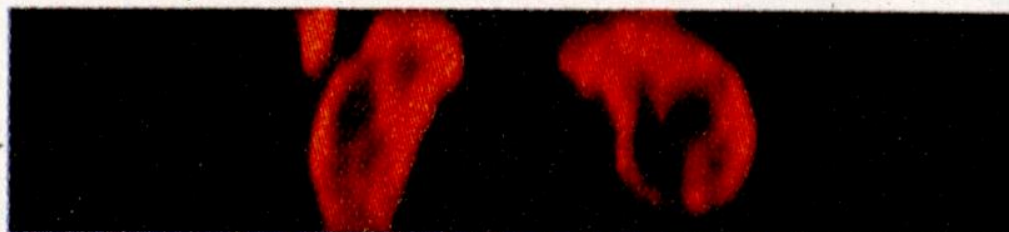
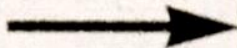

ステップとPIで染められた核
像

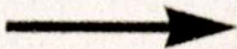

多核細胞の断層像

Plan Neofluar 40 × / 1.3 油浸

xyz

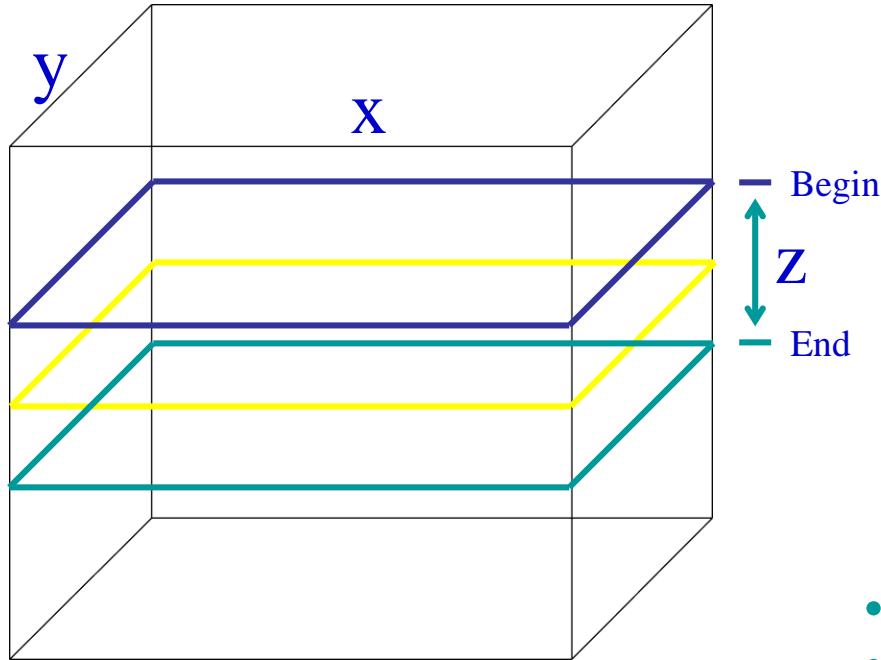

Beam is scanned
in x and y direction
and sample is moved
in z via galvo stage or
electronic focus of
microscope

- Developmental Biology
- Neuroscience

- Optical sectioning,
- 3D stacks
- 3D projections
- 3D Animations
- Structural information from large focal depth – just depending on the stack size!

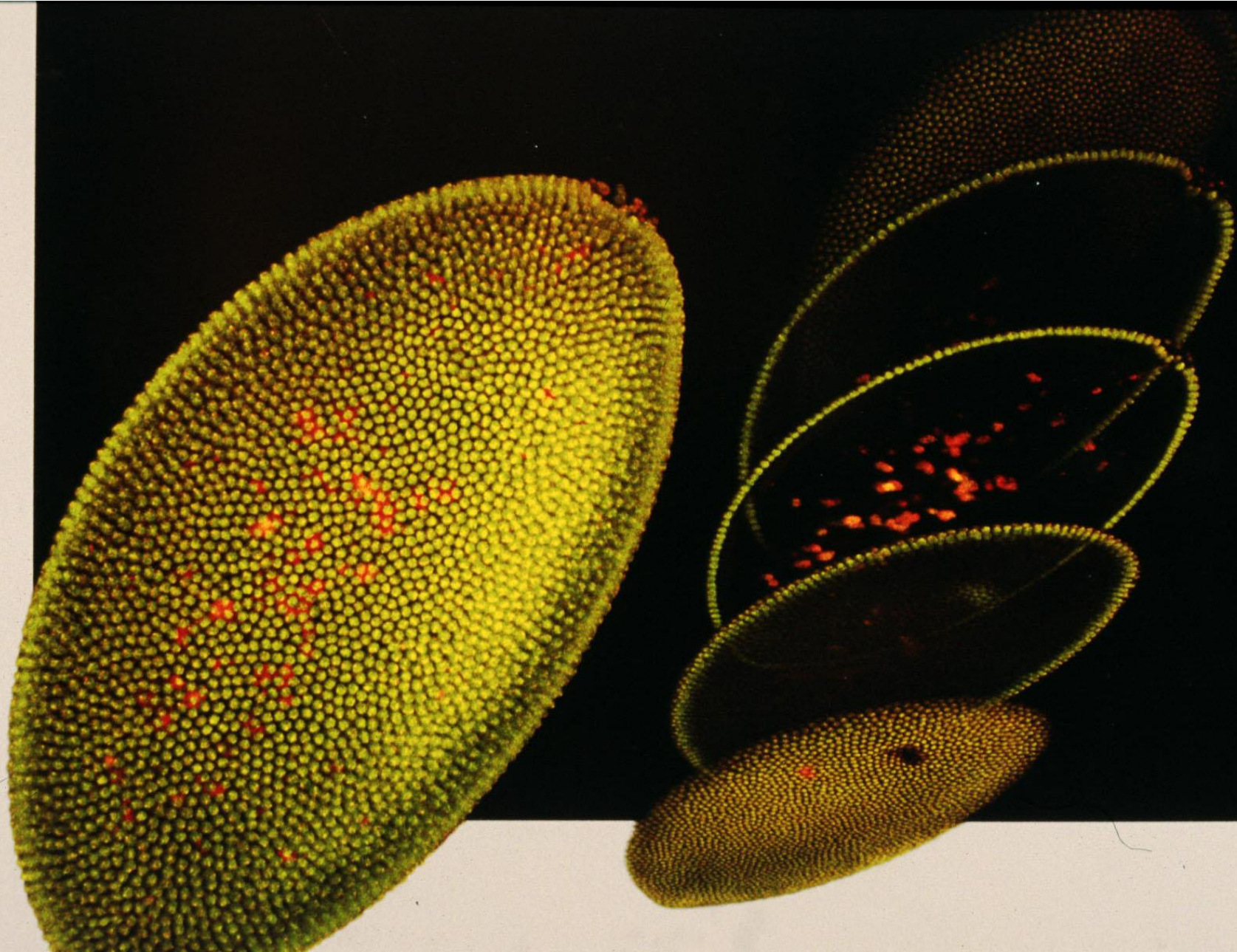

3D (xyz) series Continuous scanning

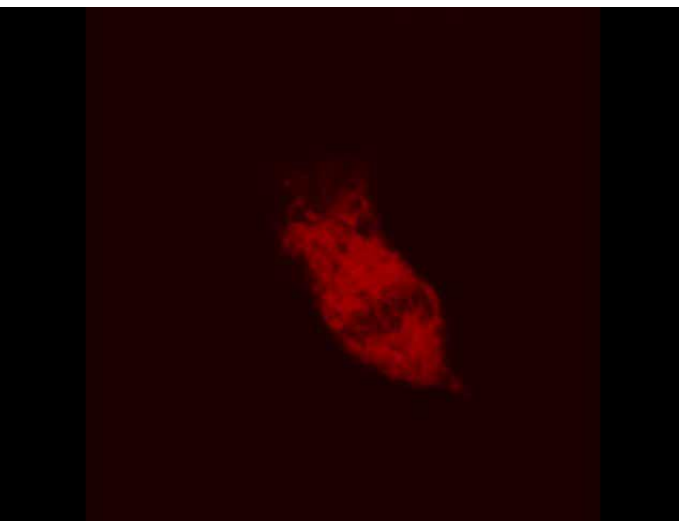

Series Scan Overview

Mode: xyz

Y 512
X 512
Z 166.68 μm

Pos: -7.14 μm
Begin: 39.87 μm
End: -50.25 μm
Total: 90.12 μm

Begin
 End

Close

A 3D schematic of a scan volume. The X-axis is labeled 'X 512' in red, the Y-axis is 'Y 512' in green, and the Z-axis is 'Z 166.68 μm' in yellow. A yellow line indicates the 'Pos' at -7.14 μm, a green line indicates the 'Begin' at 39.87 μm, and a red line indicates the 'End' at -50.25 μm. The total scan length is 90.12 μm. There are checkboxes for 'Begin' and 'End', both of which are checked. A 'Close' button is located at the bottom right of the window.

1
2
3
4
6
8
10
14
16
18
20
25
30
40
50
Others...
Close

1
2
3
Sect

A vertical list of scan numbers from 1 to 50. The number 10 is highlighted in red. Below the list is an 'Others...' button and a 'Close' button. To the right, there is a 'Sect' button with a small icon showing three stacked sections labeled 1, 2, and 3.

Number of optic sections

Acquire View 3 D Process Quantify Annotate

Beam Mode Single Scan Continuous Speed Pinh Begin Sect Series
Obj Format Phase Zoom End Aver

Gain PMT 1 Offset PMT 3 Gain PMT 3 Phase Pinhole Zoom Offset PMT 2

A software control panel with several sections. The top row contains navigation buttons: Acquire, View, 3 D, Process, Quantify, and Annotate. Below this are two rows of functional buttons. The first row includes Beam, Mode, Single Scan, Continuous, Speed, Pinh, Begin, Sect, and Series. The second row includes Obj, Format, Phase, Zoom, End, Aver. At the bottom, there are status indicators for Gain PMT 1, Offset PMT 3, Gain PMT 3, Phase, Pinhole, Zoom, and Offset PMT 2.

Application

3D-Section

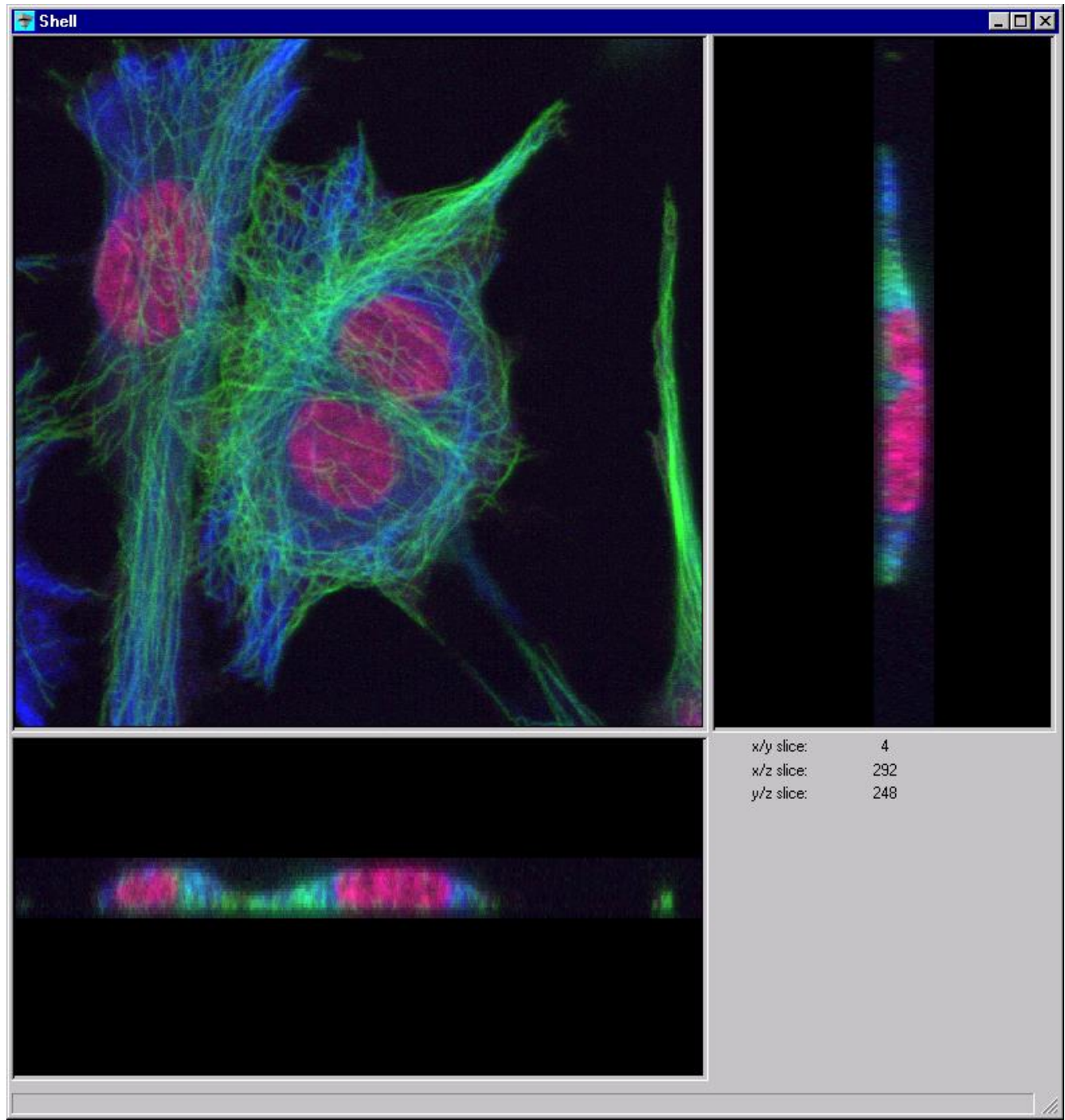

xy scanning, special: ROI (region of interest)

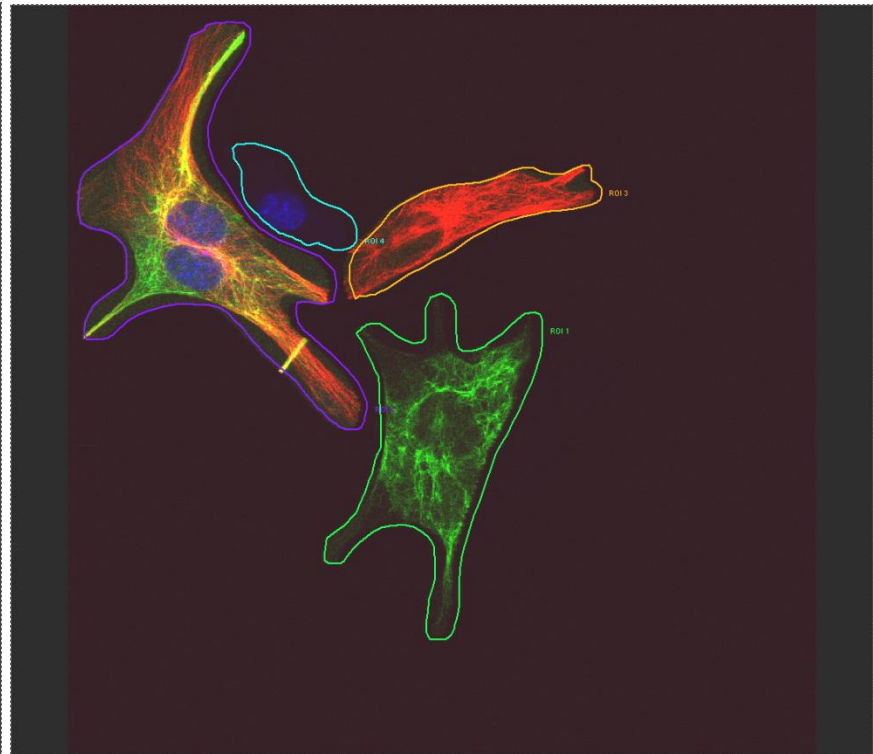
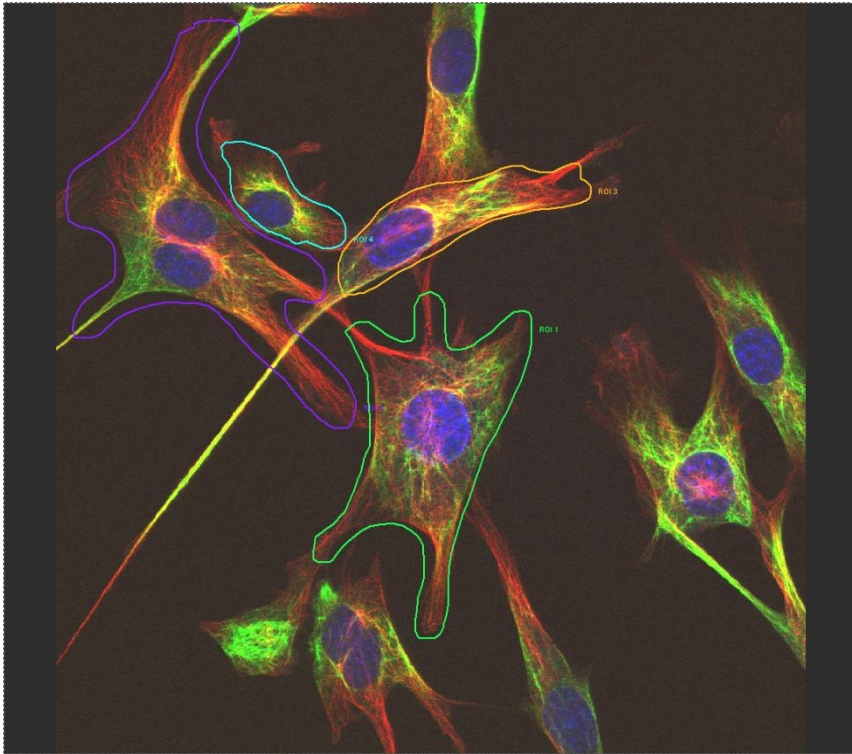

- Freely configurable laser lines and intensities for ROI's and surrounding area
- FRAP
- Uncaging

Fibroblasts

ROI 1 543 Cy3 (Intermediate Filaments)

ROI 2 all lines

ROI 3 488 FITC (Microtubules)

ROI 4 UV DAPI (Nucleus)

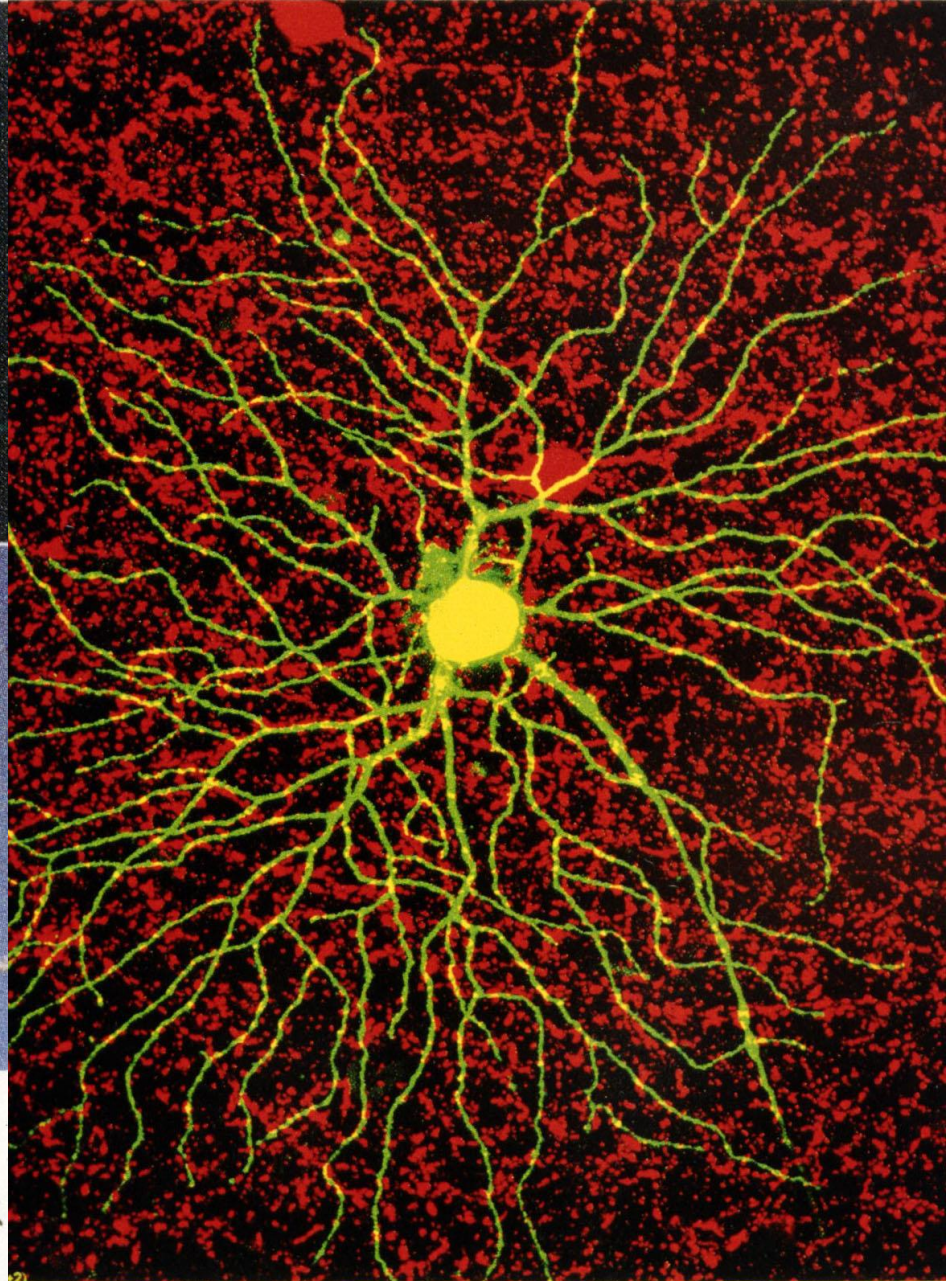
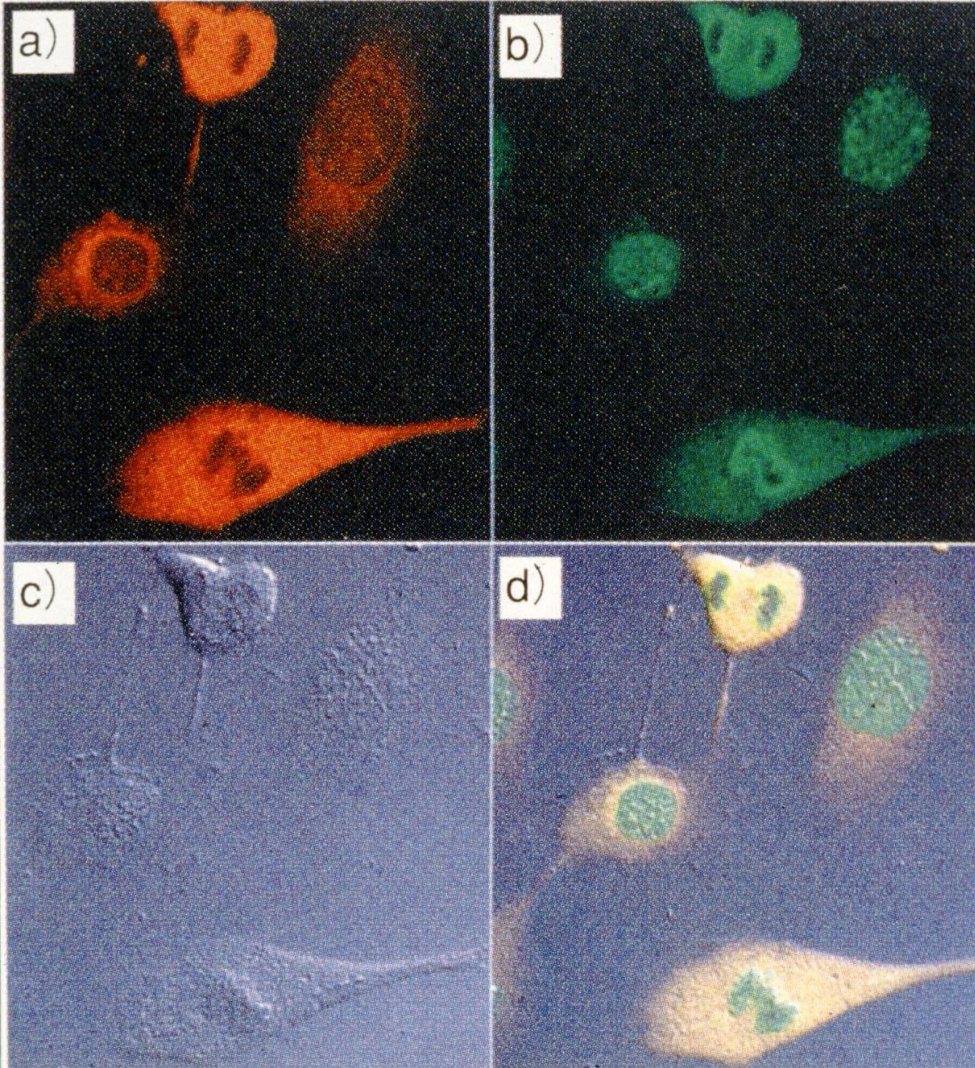

12 FITC, Rhodamine, 微分干渉および合成像
 a) F-アクチン/Rhodamine 染色像, b) クリスタリン/FITC 染色像, c) 微分干渉像, d) 合成像.
 ラット由来の筋芽細胞 (L-6) の観察像.
 東京大学大学院総合文化研究科広域科学専攻生
 環境科学系跡見順子先生より提供

細胞とドーパミン作動性アマクリン細胞のレーザー顕微鏡エクスタ
 像. Lucifer Yellowで網膜神経節細胞, Texas Redでドーパミン
 を染色.



図 4 ラット腎臓内の小
C-Apochromat 63
3-5-2) One point
富山医科薬科大学
高田正信先生より

Multi-dimensional Live-cell Imaging System

Functions:

1. Provide non-invasive ways to observe and measure the *in situ* behavior of gene products.
2. Analysis of the dynamics of proteins association/dissociations at cellular structures.

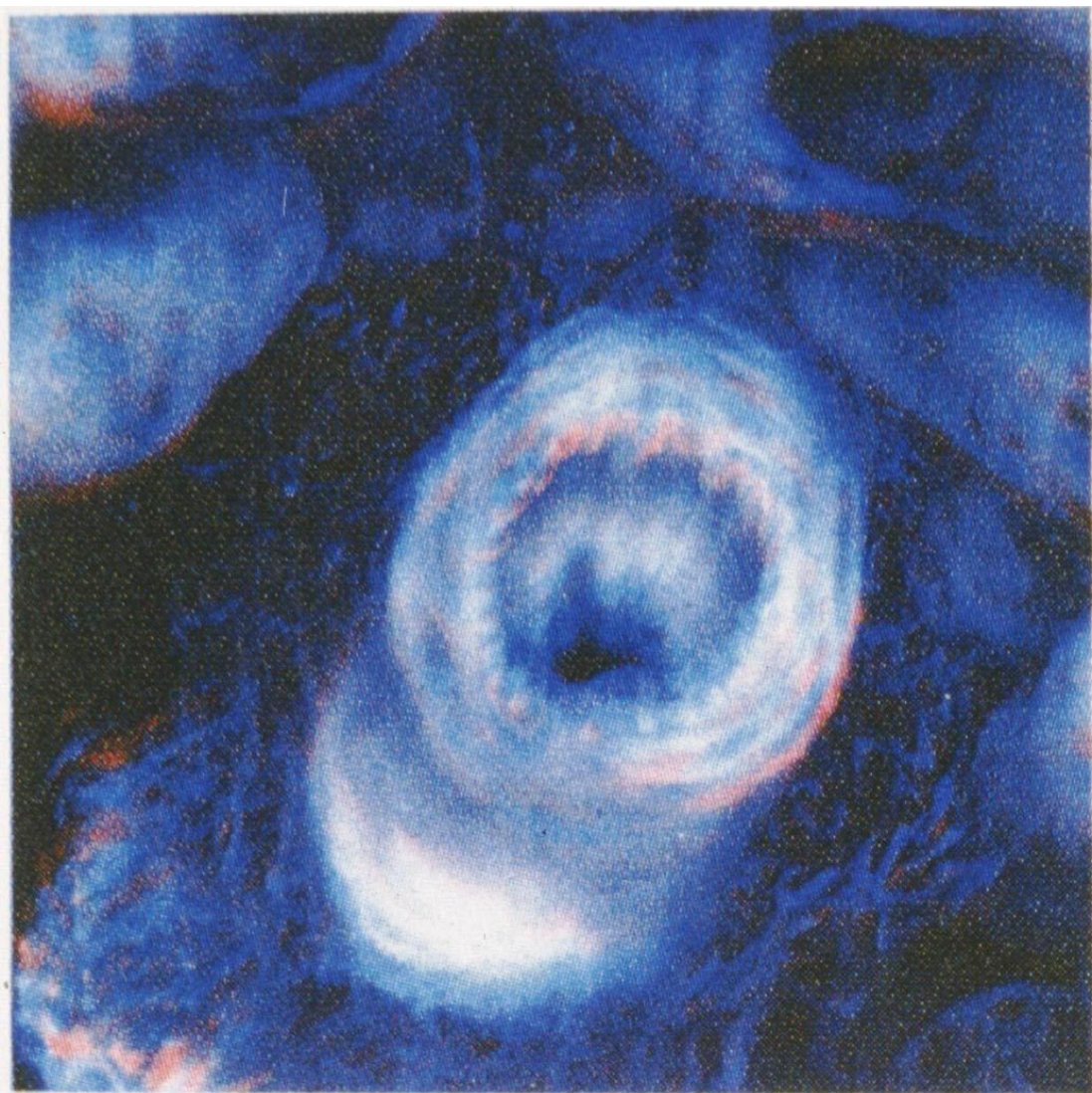
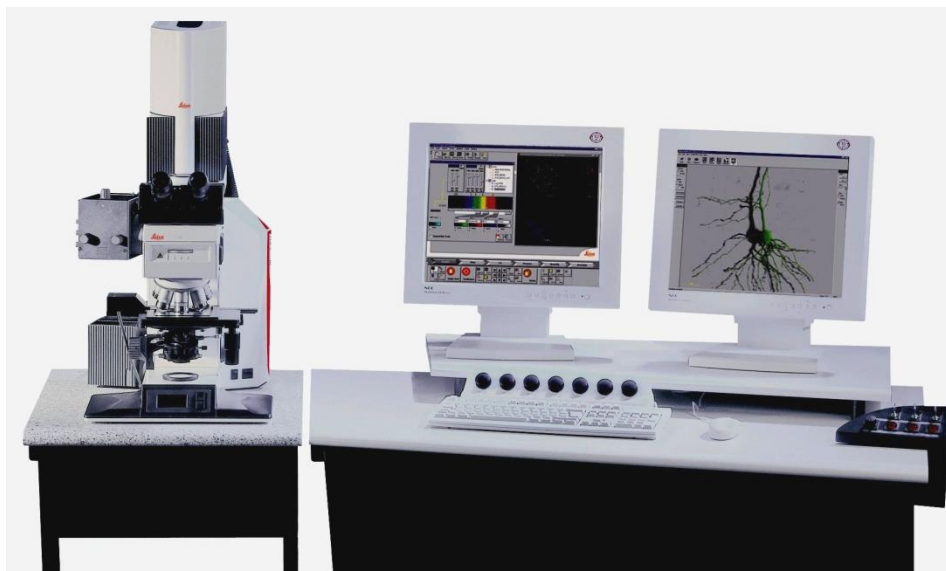

Time-Series

- Line-Mode „xt“

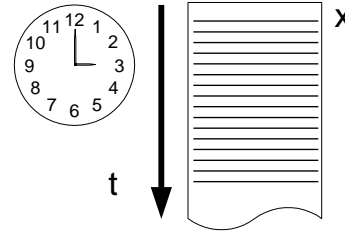

- Frame-Mode „xyt“

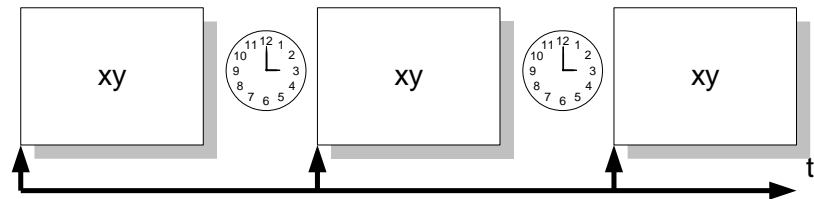

- Stack-Mode „xyzt“

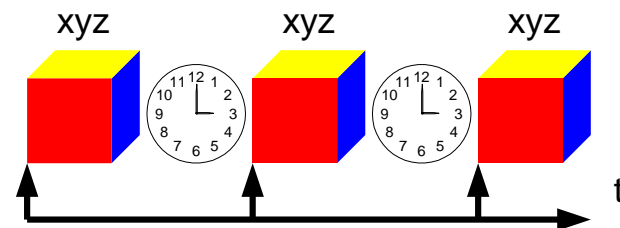

Traditional Live Cell Observation

Up-right microscope with Water Lens or Inverted microscope

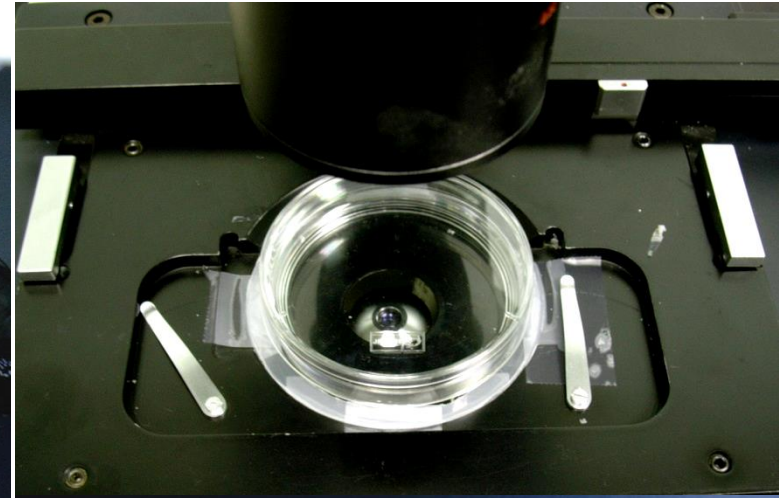
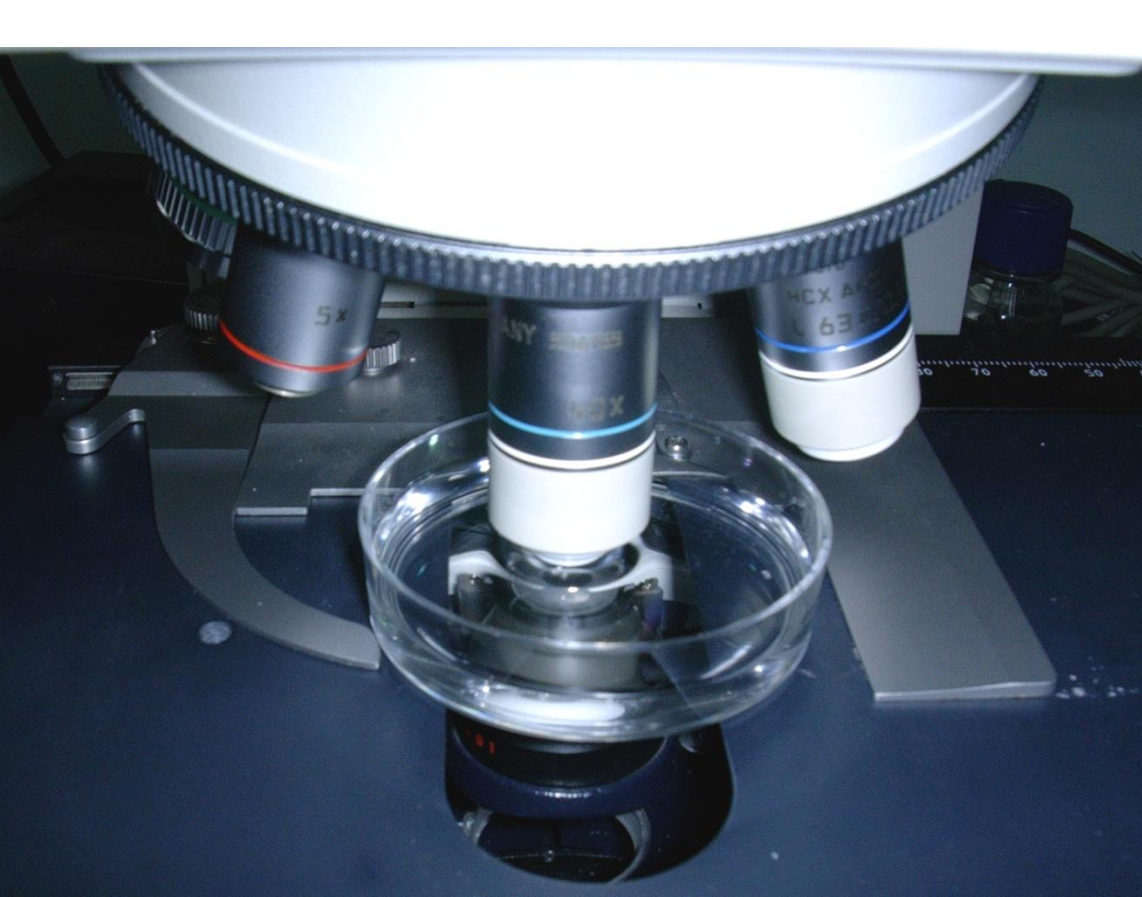

2) 倒立型顕微鏡の場合

ための試料

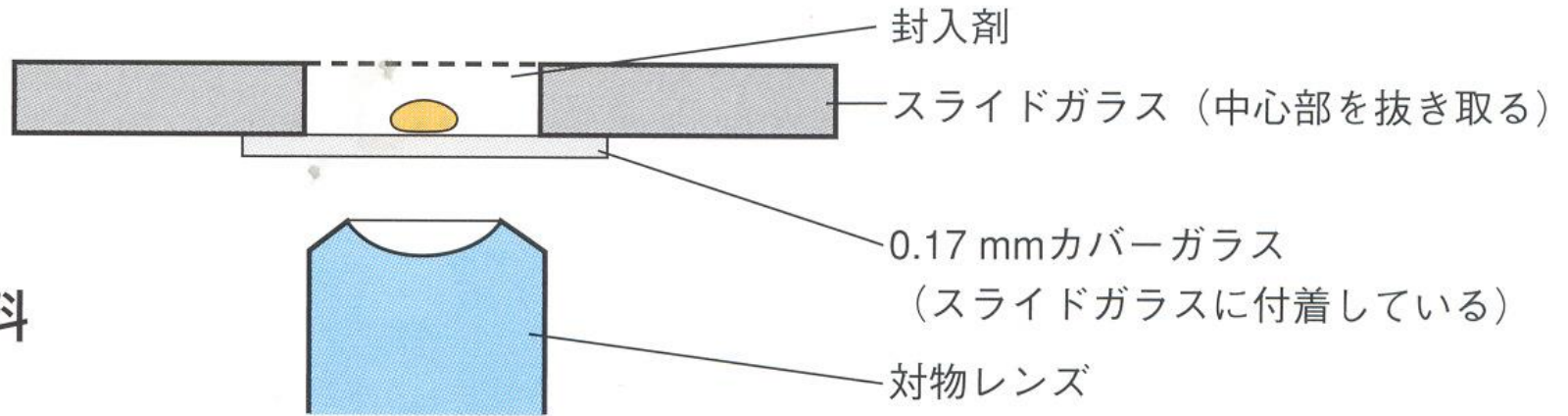

NUNC FLASKETTE® CHAMBER SLIDE/FLASKS

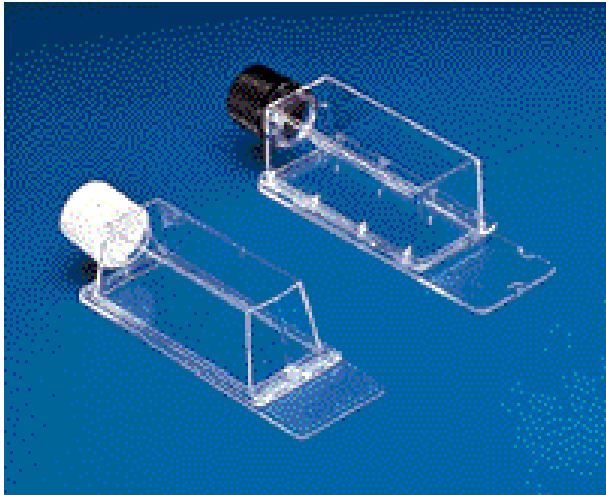

LAB-TEK® II CHAMBERED COVERGLASS

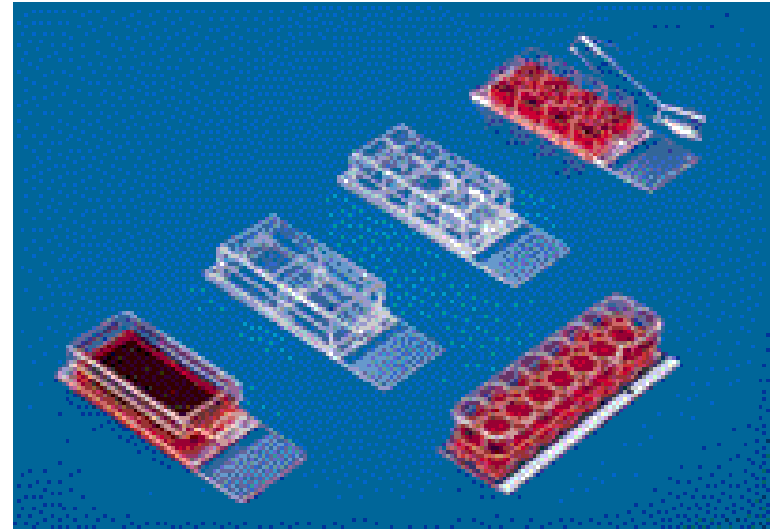

Computerized Fluorescence Inverted Microscope Leica DM IRE 2 HC



**Universal Microscope Controller
with
Remote Control Knob**

Objectives :

The best axial and lateral resolution
Optimized correction for cell-imaging

HCX PL-APO 10x/0.40 Ph 1

HCX N Plan L20x/0.40 Ph 1, 0-2 mm corr

HCX PL-Fluotar L40x/0.60 Ph 2, 0-2 mm corr

HCX PL-APO 100x/1.35 OIL Ph 3

Sutter DG-4 light source:

- Quick wavelength switcher (<2msec)
- Quick shutter and modulator of output energy
- 175 Watt xenon lamp

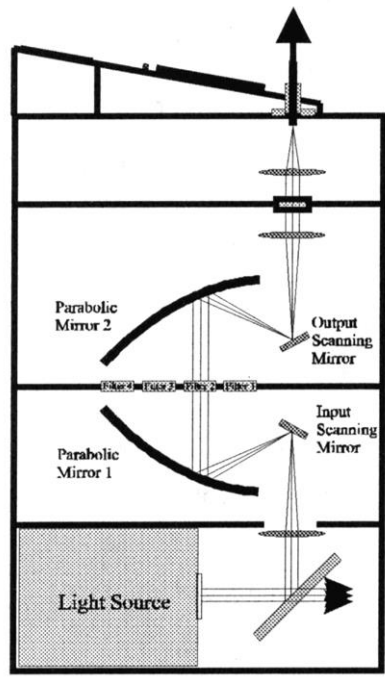
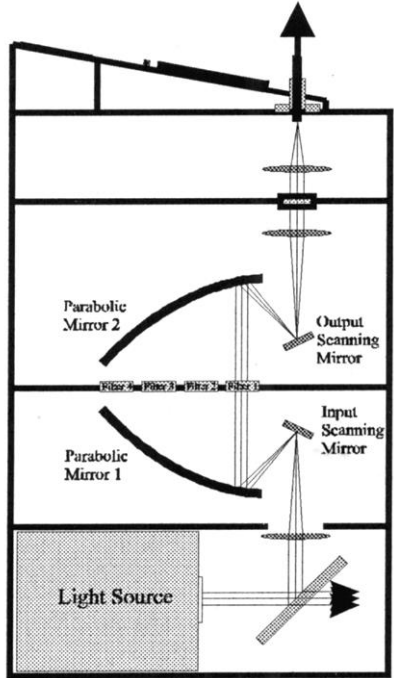
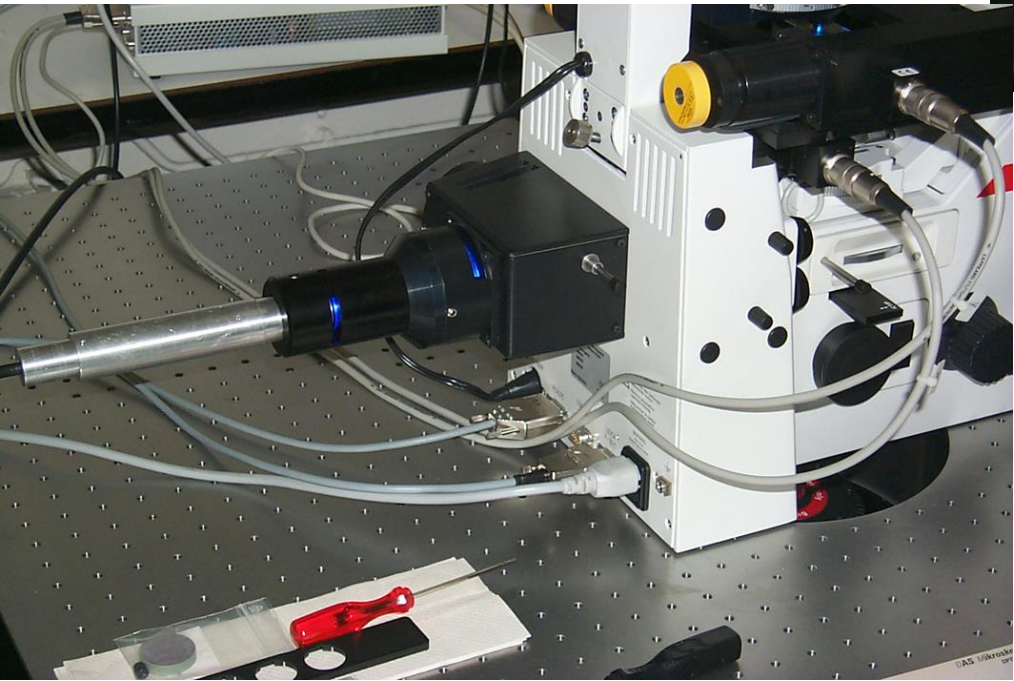

Even and planar illumination: Light source is coupled to the microscope *via* an optical fiber

Filter Position 1

Filter Position 2

Computerized Fluorescence Inverted Microscope

Leica DM IRE 2 HC

Fluorescence Filters

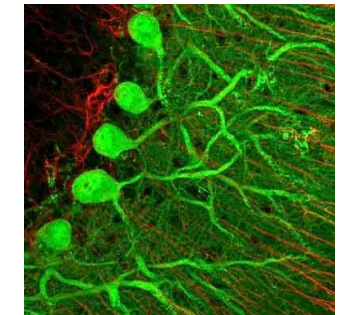
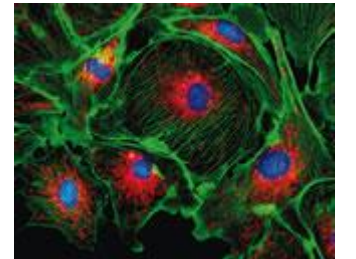
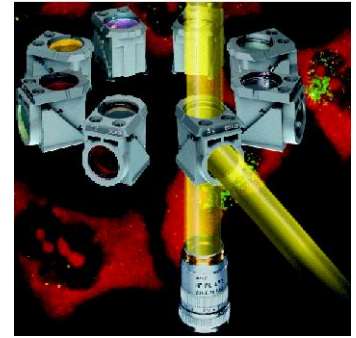

Built-in Four Microscope Filters

- GFP
- CFP
- YFP
- DsRed

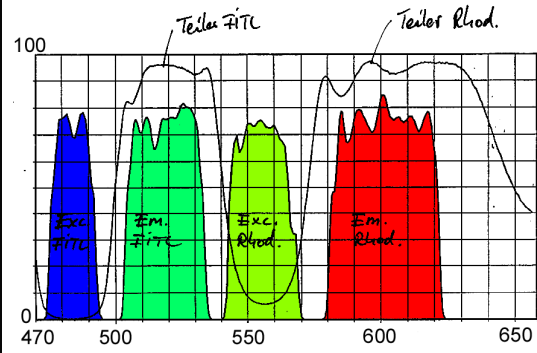
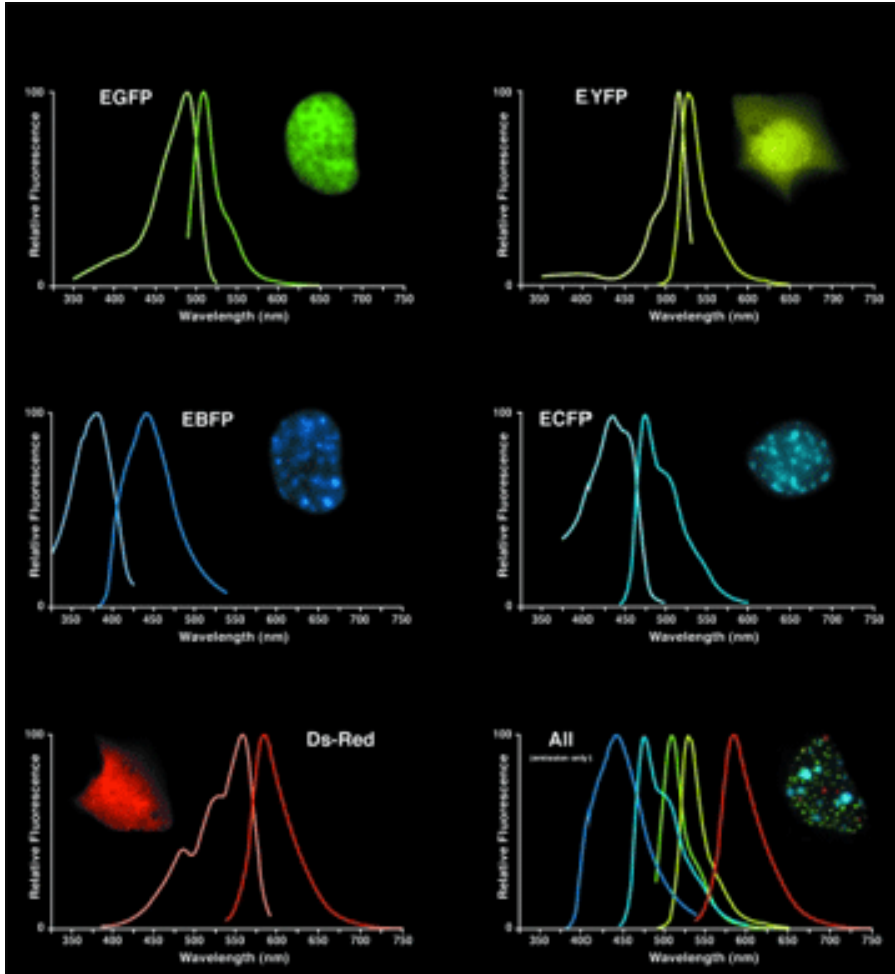

Computerized Z-positioner To obtain the Stack Imaging

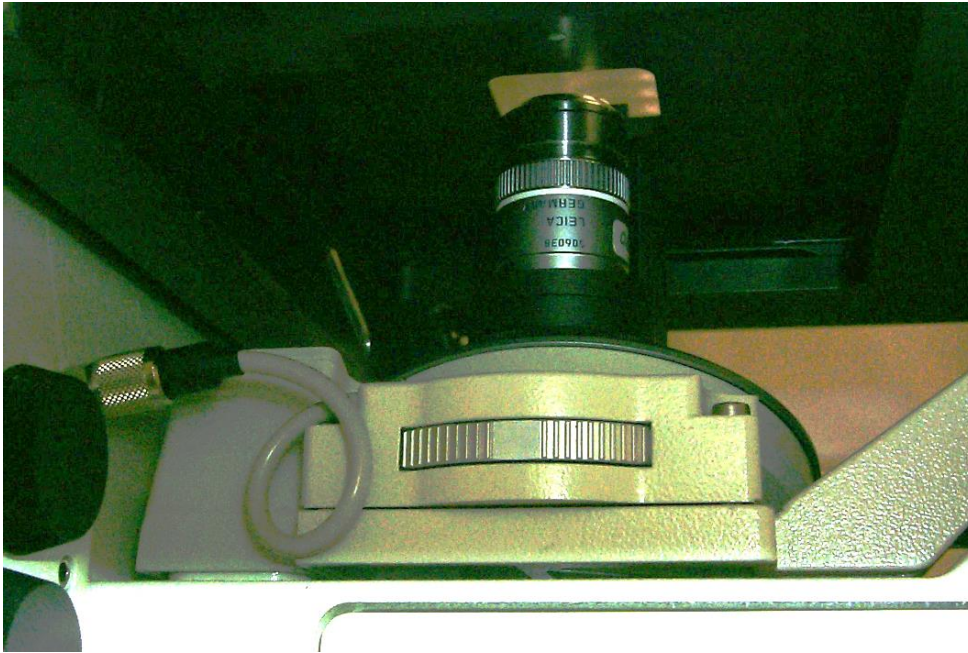

The precision nosepiece
to be controlled by

1. Remote Control Knob
2. Software (MetaMorph)

100x Plan APO HCX CS N.A. 1.35
matched R.I. immersion oil

Leica DM IRE2 microscope
*enclosed within a computerized CO₂-incubator for
indispensable thermal and mechanical stability*



CO₂ controller



**Microincubation
Imaging-Chamber**

Microincubation imaging-chamber: mechanical stability

Open / Close / Perfusion

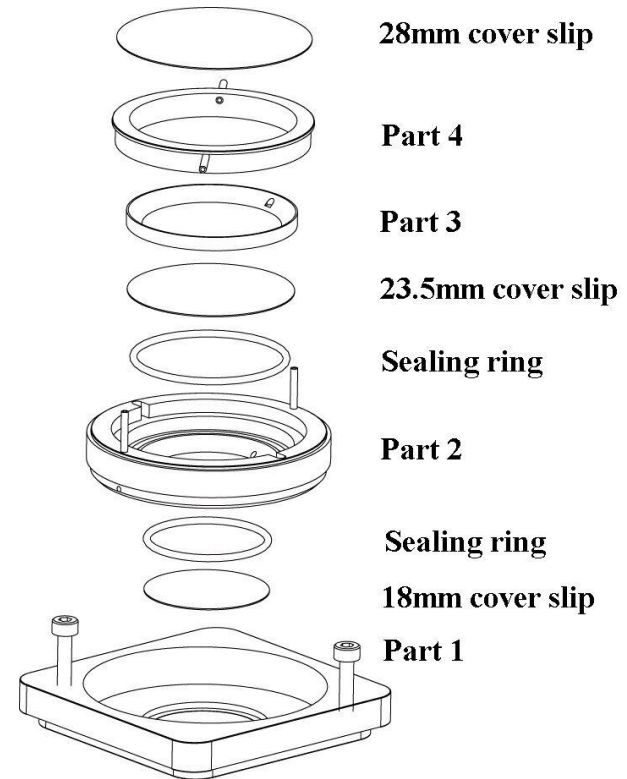

28mm cover slip

Part 4

Part 3

23.5mm cover slip

Sealing ring

Part 2

Sealing ring

18mm cover slip

Part 1

A Stable System on the vibration-free table

Beads Do Not Move during 2-Color 4-D Acquisitions

Measured light intensities at the bead's center are stable

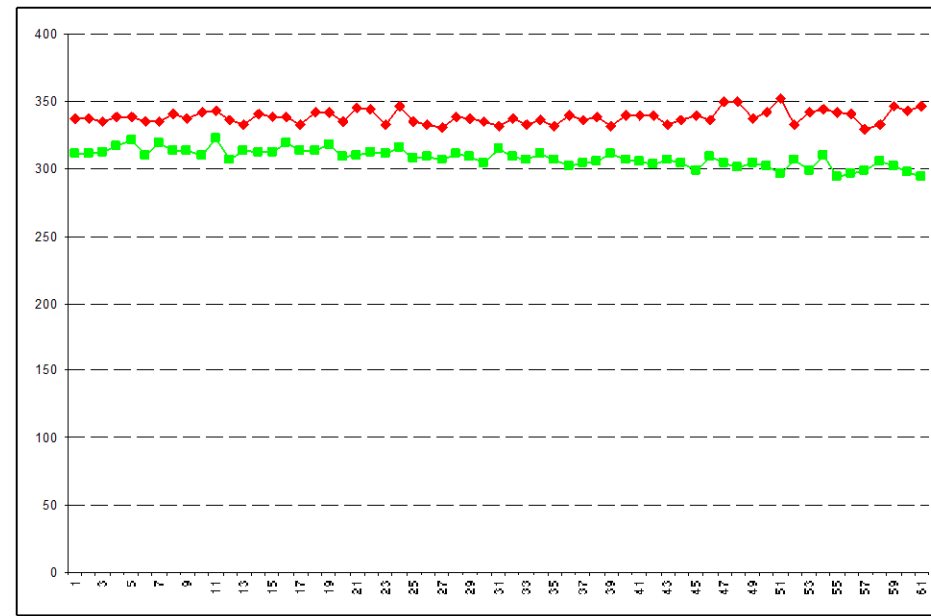
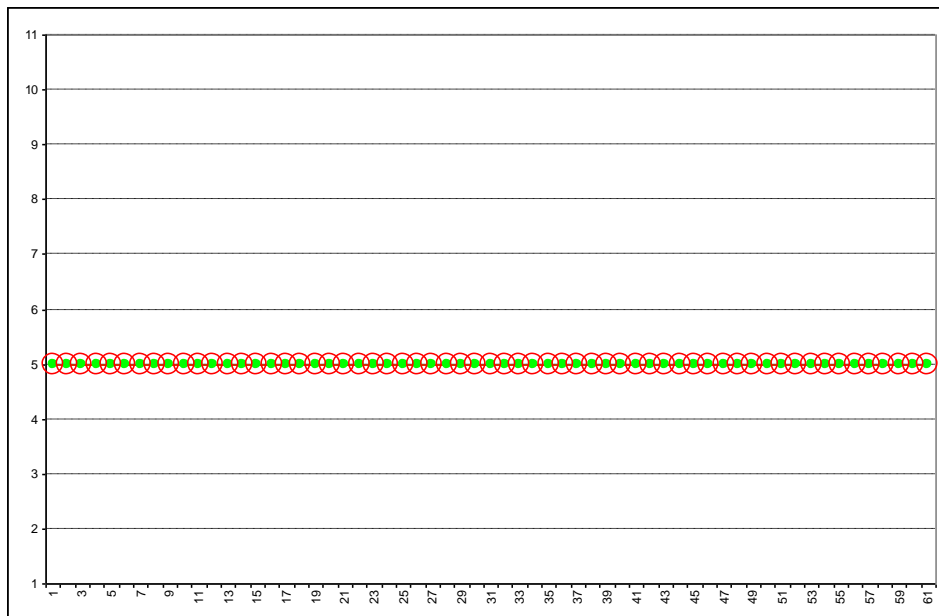

Roper Scientific Cooled CCD Camera Cool SNAP-HQ

High sensitivity, High Resolution, High Speed

- Interline Progressive Scan 1392 x 1040 pixels
- Pixel size: 6.45 x 6.45 μm
- Low read-out noise: 6 e⁻/sec at 10 MHz, 8 e⁻/sec at 20 MHz
- Electronic shuttering, “full speed overlapped” read-out
- programmable read-out capabilities (subregion, binning)
- - 30 °C Cooling – reduce noise

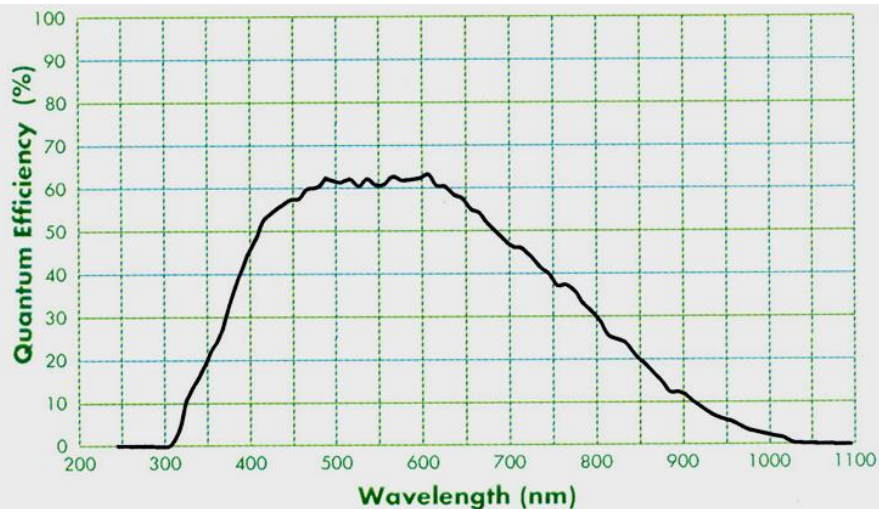

	Region		
	1392 x 1040	512 x 512	256 x 256
1 x 1	10	19	30
2 x 2	18	30	44
3 x 3	24	38	51
4 x 4	29	43	56

(Frames per second)

Note: Frame rates are measured at 20 MHz with 0-second exposure times.

Software: MetaMorph System

integrated imaging system for maximized control

1. Multi-dimensional imaging
2. 3D reconstruction/ deconvolution
3. Time lapse recording
4. Z-series acquisition
5. Morphometry: Cell counting

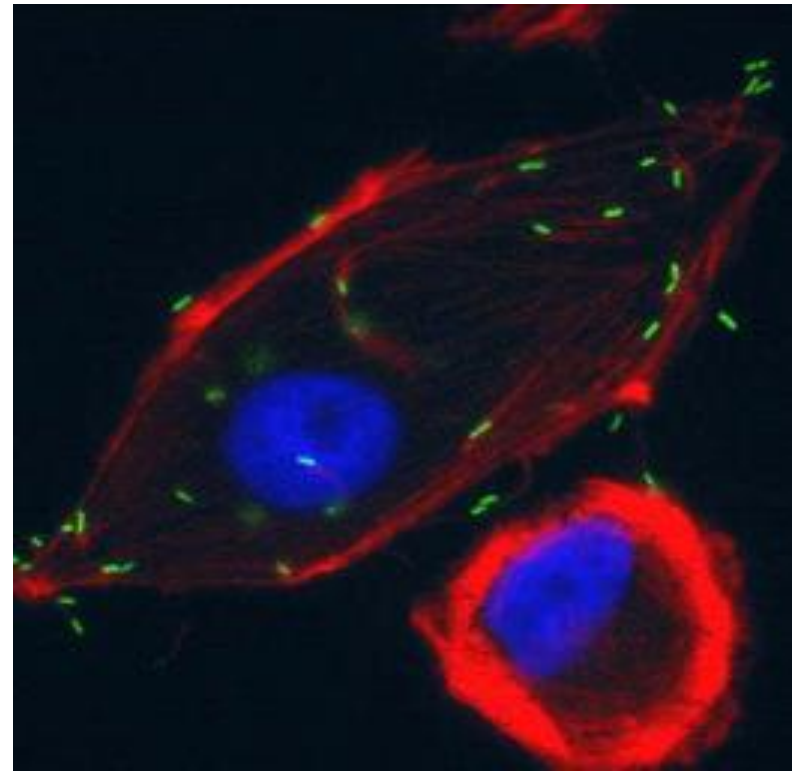
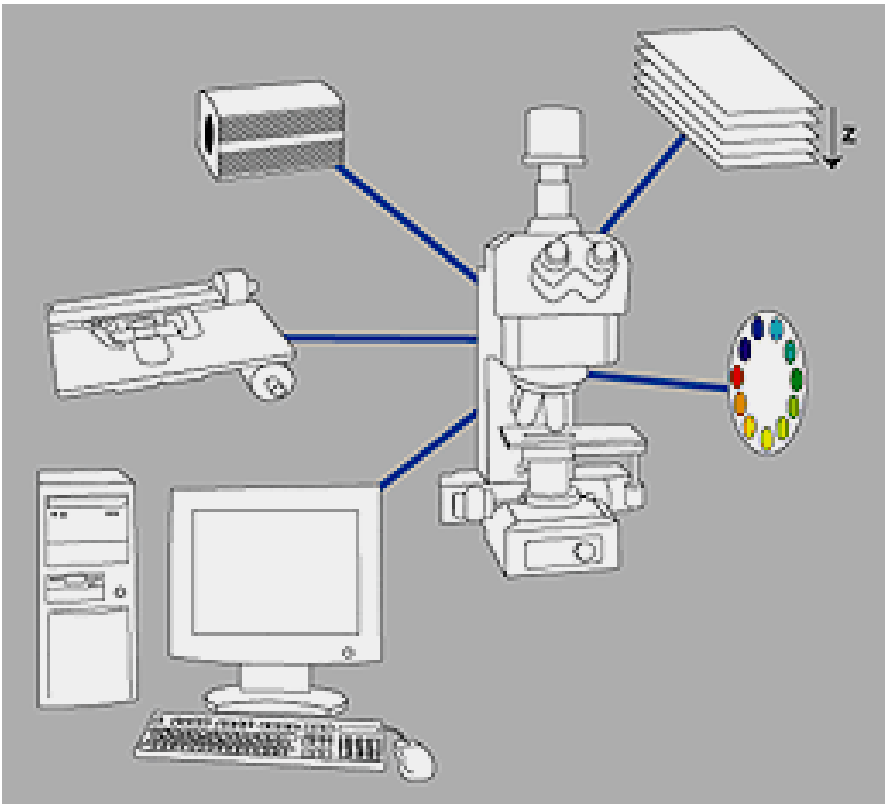
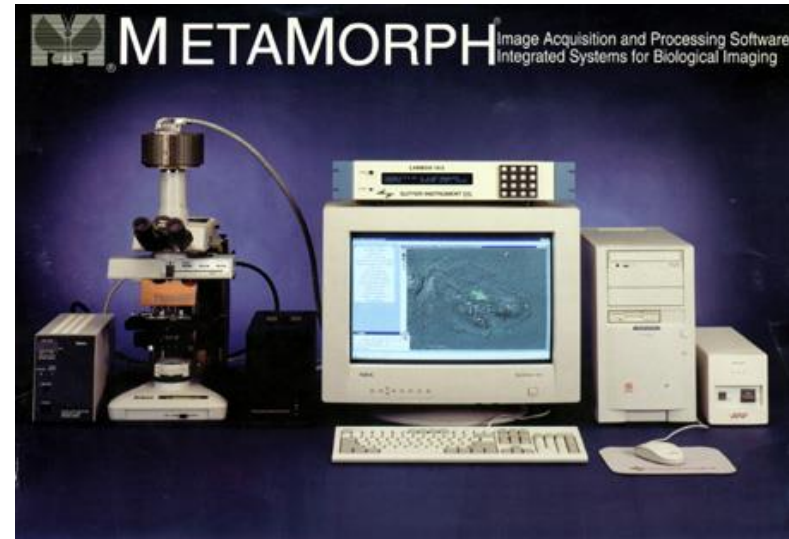



Real-Time

Cultured Cell Monitoring System

— Supporting the Challenge of Discovery —



Designed to Fit...

Designed to Resist...

Designed to Discover...

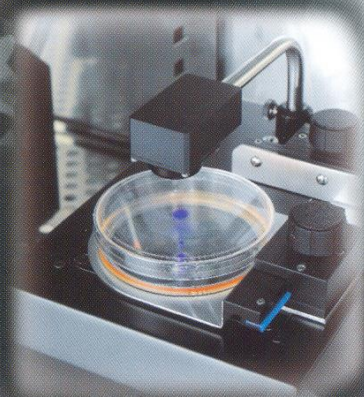

Microscope Now Rests in Incubator!!

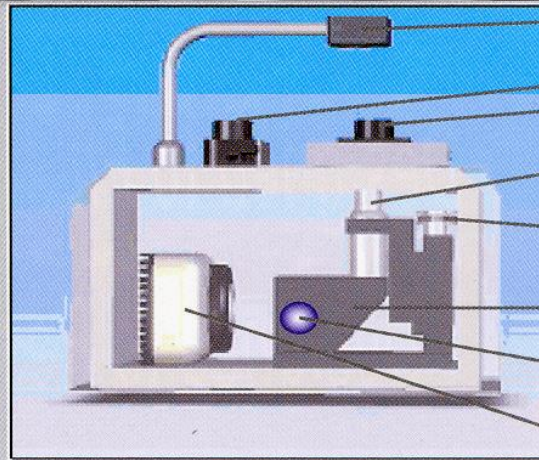

- White LED
- Sample Stage Dial
- Objective Lens
- Motorized Focus
- Fluorescence Filter Unit
- Blue LED
- CCD Camera

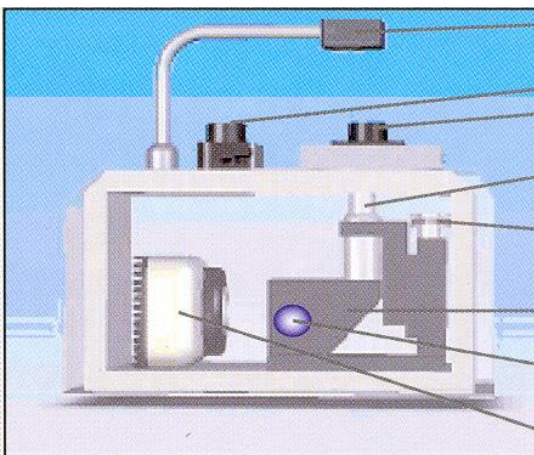

ASTEC

弘優科技代理

•Real-Time
Cultured Cell
Monitoring
System (MSC
Normal light)

	CCM-330F	CCM-500F
Resolutions	3.3 Mega Pixels (2048x1536)	5.0 Mega Pixels (2560x1920)
Camera / Chip Size	Cooled CCD / 1/2 Inch	Cooled CCD / 2/3 Inch
Cooling	Peltier Device RT-10°C	Peltier Device RT-10°C
Pixel Size	3.45µm x 3.45µm	3.4µm x 3.4µm
Field of View (Objective X10)	707 x 530 µm	870 x 650 µm
Exposure Time	1.6µs x 17.9min	1.6µs x 17.9min
Capturing Interval	1min - 24h	1min - 24h
Image Format	TIFF / BMP	TIFF / BMP
Objective Lens (Standard)	X 10 / NA0.22	X 10 / NA0.22
Integrated magnification (17" LCD monitor)	X 440	X 360
Light Source (VIS)	White LED	White LED
Light Source (FL)	Blue LED	Blue LED
Excitation Filter	472.5nm Half band width 30nm	472.5nm Half band width 30nm
Fluorescence Filter	520nm Half band width 35nm	520nm Half band width 35nm
Dichroic Mirror	503nm - 730nm	503nm - 730nm
Focus Adjustment	Remote Control from the Controller	Remote Control from the Controller
PC	WindowsXP Professional SP2	WindowsXP Professional SP2
CPU	Intel Pentium4, 3.0GHz 512MB and up	Intel Pentium4, 3.0GHz 512MB and up
Standard Display	SXGA 17" LCD display	SXGA 17" LCD display
Camera Unit Dimensions	W165 x D275 x H165 (8.0kg)	W165 x D275 x H165 (8.0kg)
Controller Dimensions	W220 x D260 x H120 (6.0kg)	W220 x D260 x H120 (6.0kg)

Real-Time Cultured Cell Monitoring System



— Supporting the Challenge of Discovery —



Designed to Fit...
Designed to Resist...
Designed to Discover...

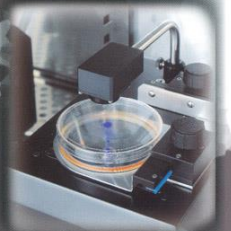

Microscope Now Rests in Incubator!!

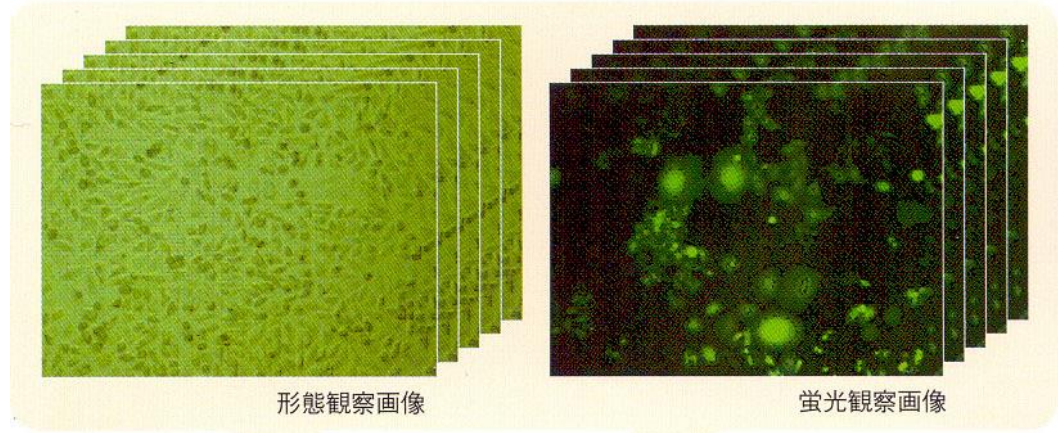
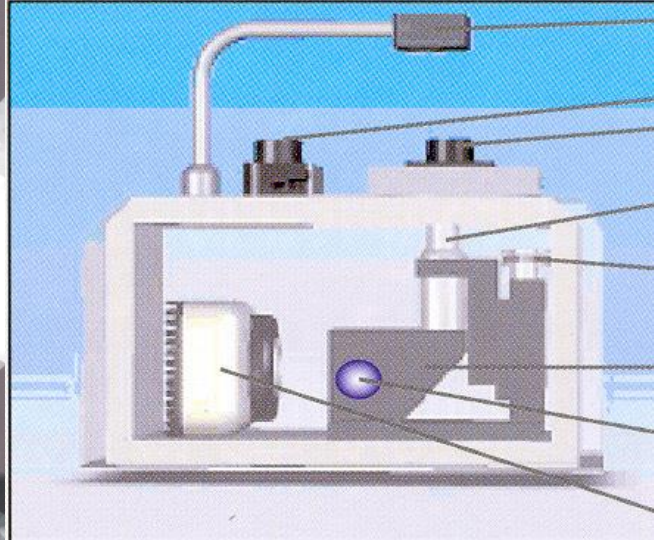

形態観察画像

蛍光観察画像



・撮影

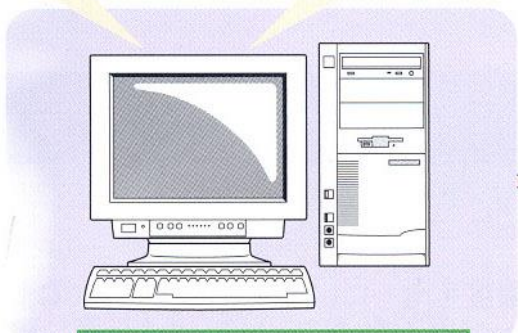

・画像取込 ・編集



・ライトコントロール
・エアープンプ
・フォーカス

ASTECCCM-MULTI

■ 機器仕様：インキュベーター部

内 容 量	80L
外 形 寸 法	W735×D510×H760mm
内 形 寸 法	W418×D377×H510mm
棚 板 寸 法	W350×D350×H11mm
加 温 方 式	エアージャケット
温度制御方式	デジタルPID
温 度 範 囲	室温+5°C~50°C
温 度 精 度	±0.3°C
加 湿 方 式	自然蒸発(バット注入)
湿 度	95±3%RH (5%CO ₂ 時)
CO ₂ 制御範囲	0~20%
CO ₂ 精 度	±0.1%
O ₂ 制御範囲	2~18% (オプション)
O ₂ 精 度	±0.5% (オプション)
製 品 質 量	78kg
電 源	AC100VMax7A 50/60Hz (インキュベーター専用)
電 源	AC100VMax5A 50/60Hz (カメラユニット関連用)



カメラユニット
内部の温度を
管理します。

ラット受精卵 (対物20× 5分間隔で撮影)



2細胞期から4細胞期。
受精卵の中には、極体も
確認できる。



殆どの受精卵が4細胞
期に移った。

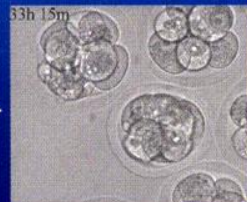

8細胞期。

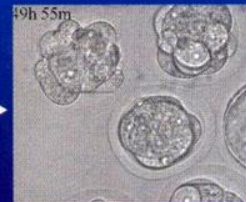

細胞同士の接着性が変
化し、コンパクションが
発生する。



胚盤胞となり、次第に透
明帯を破るハッチングが
確認されるようになる。

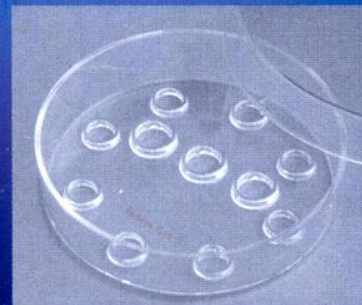

IVFディッシュGPSにて
受精卵を観察撮影

ASTECCCM-MULTI

■ 機器仕様：カメラユニット部

画素数	140万画素(1392×1040)
イメージセンサー	モノクロ冷却CCDカメラ
対応可能对物レンズ	4×(NA0.2)、10×(NA0.22)、20×(NA0.45)
撮影範囲	640μm×480μm(対物10×)
冷却温度	周囲温度-25℃(ペルチェ素子)
タイムラプス時間設定	1min~24hr
形態観察光源	緑色LED
形態観察方式	透過照明(偏斜照明)
蛍光観察光源	青色LED(470nm peak)
蛍光観察方式	同軸落射照明
励起フィルター	透過ピーク:472.5nm(半値幅30nm)
ダイクロイックミラー	透過幅:503nm~730nm
蛍光フィルター	透過ピーク:520nm(半値幅35nm)



■ 機器仕様：メカニカルステージ部

駆動制御	超高精度ステッピングモータ
分解能(X方向)	0.05μm(ステージ動作)
分解能(Y方向)	0.05μm(ステージ動作)
分解能(Z方向)	0.5μm(対物レンズ動作)
繰り返し誤差	XY方向10μm以内
稼働範囲	100×65mm

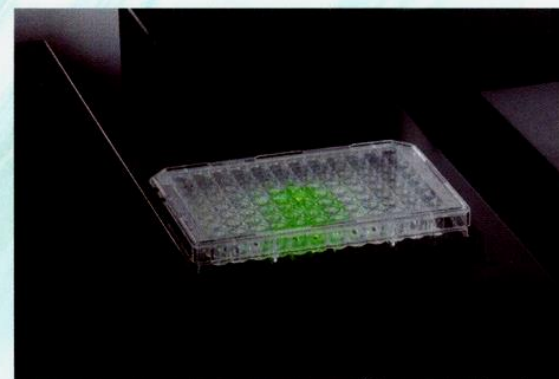

※<http://www.astec-bio.com> 弊社WEBにて
サンプルムービーをご覧になれます。

Cell migration assay / Wound healing assay

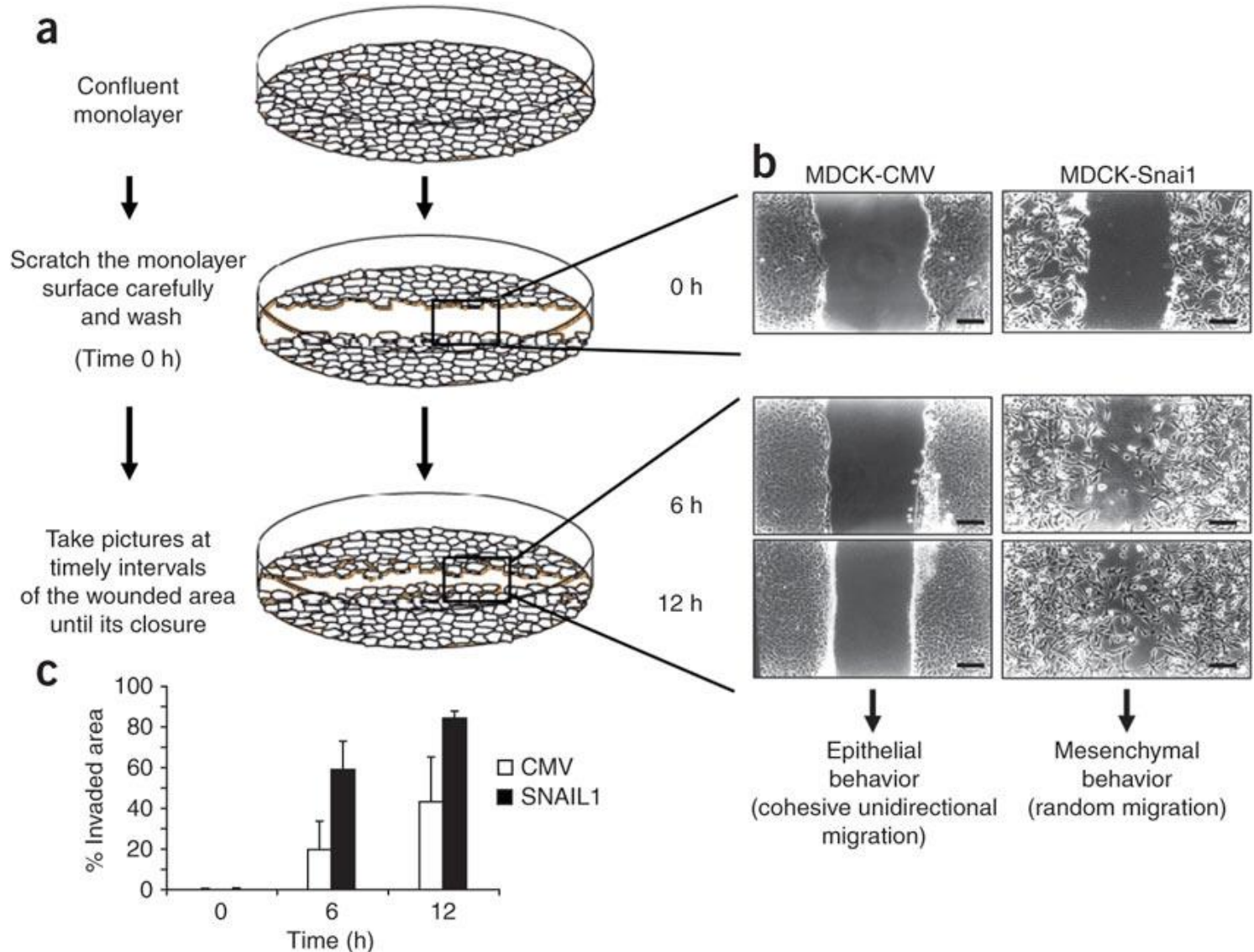

The morphological and molecular features of the epithelial-to-mesenchymal transition
 Moreno-Bueno et al., *Nature Protocols* **4**, 1591 - 1613 (2009)

IVIS™

Biology and User-Driven Technology and Instrumentation Development

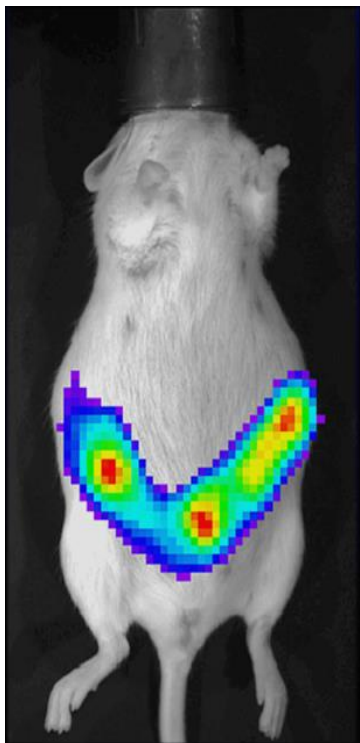

Biology



Instrumentation

IVIS Spectrum Concept

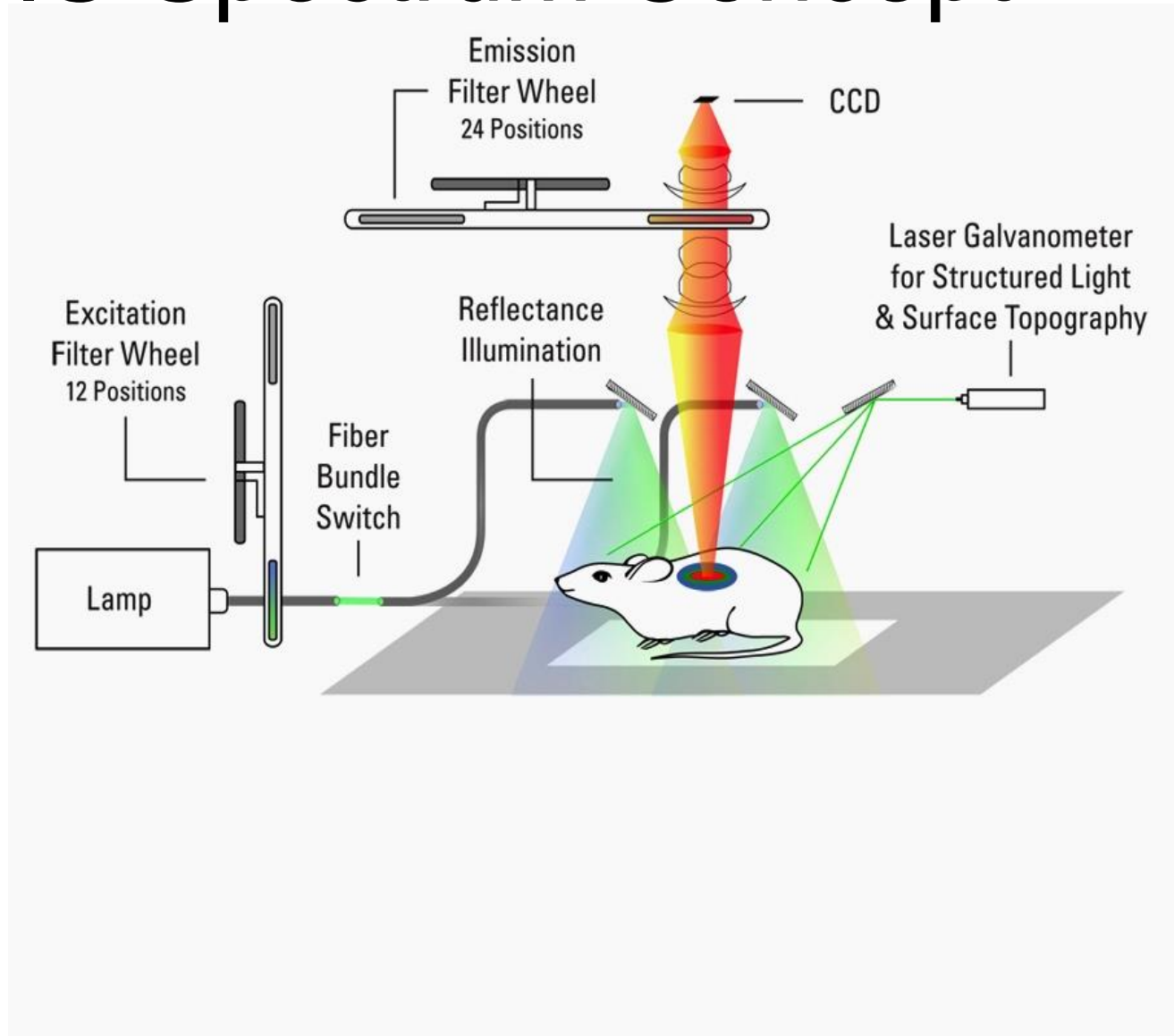

Reflection-Mode
Illumination

IVIS Spectrum Concept

Transmission-
Mode
Illumination

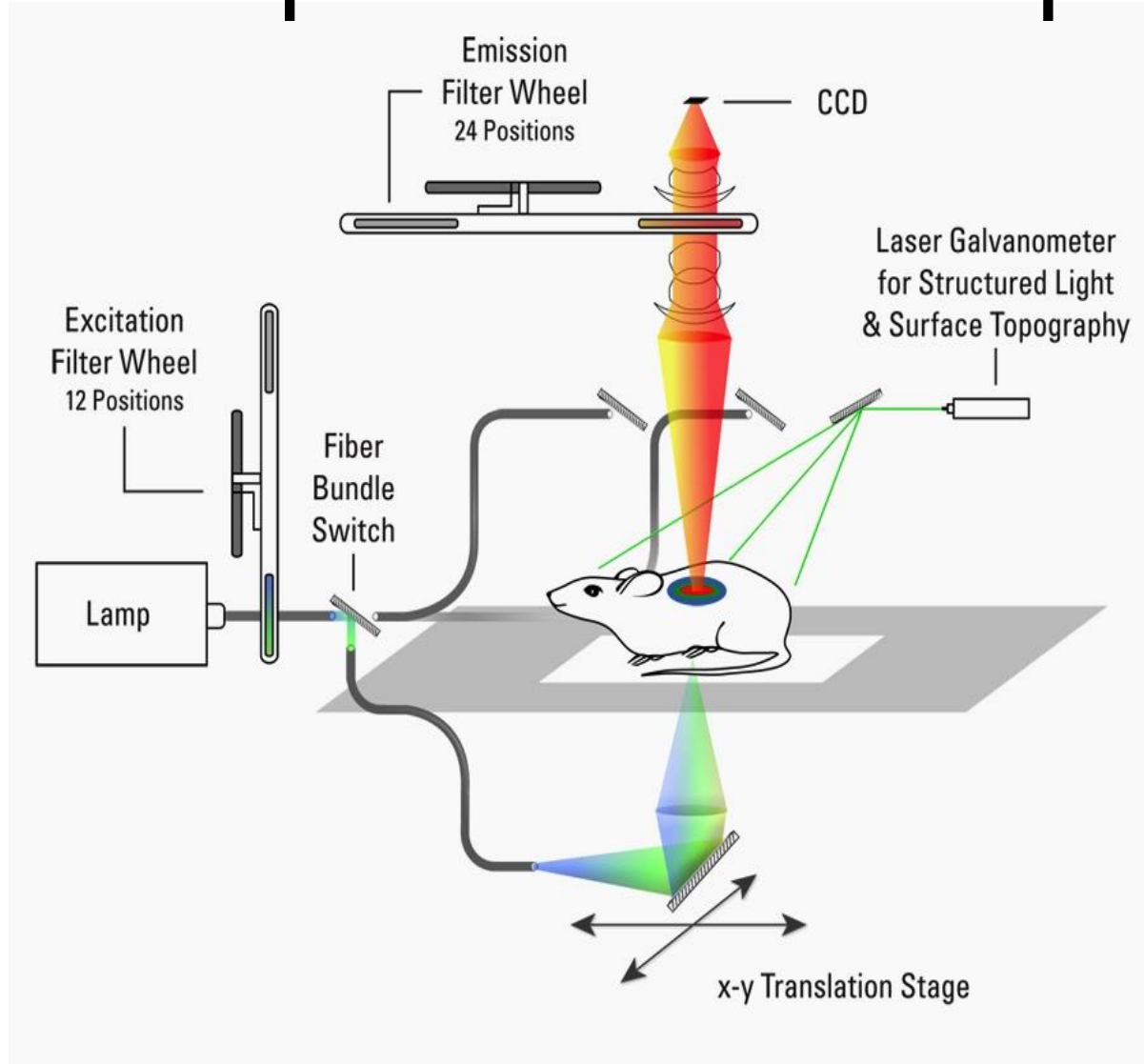

IVIS Spectrum Imaging: Sensitive, quantitative, multi-modal

In Vitro

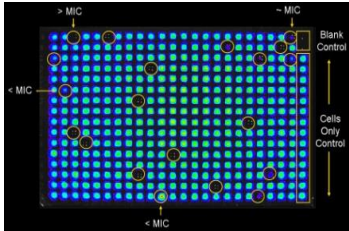

High Resolution

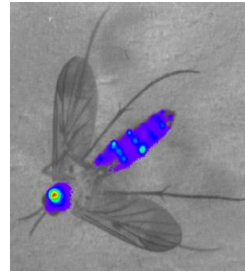

3D tomographic quantification, CT co-registration

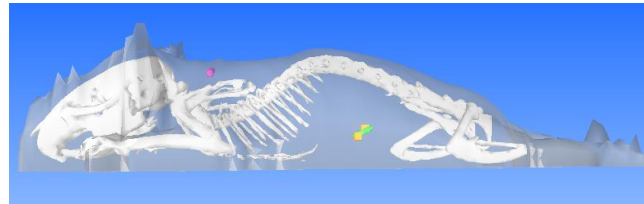

Multi-modal

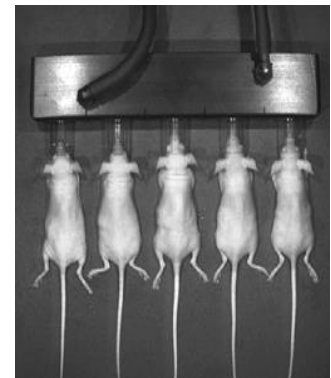
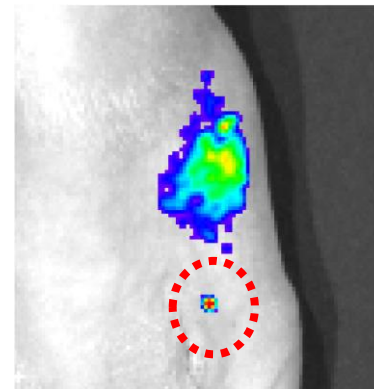
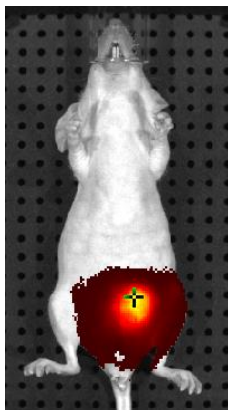
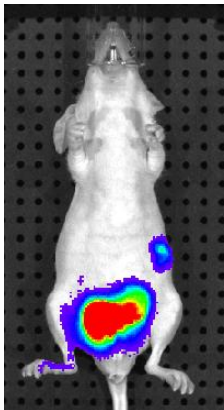

Bioluminescence
PC3M-luc

Fluorescent
Conjugate –
Herceptin®

Fluorescent
protein – GFP

Single cell sensitivity in-vivo
4T1-luc2-1A4

High throughput

IVIS Spectrum

CCD, TE-cooled to -90C

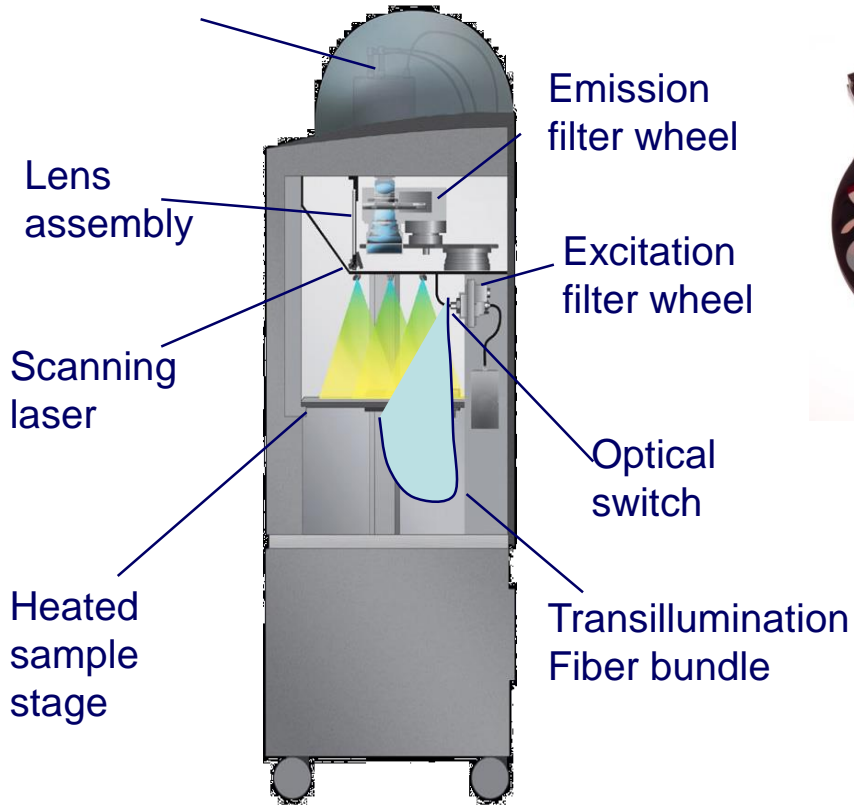

10 excitation filters (35 nm bandwidth)

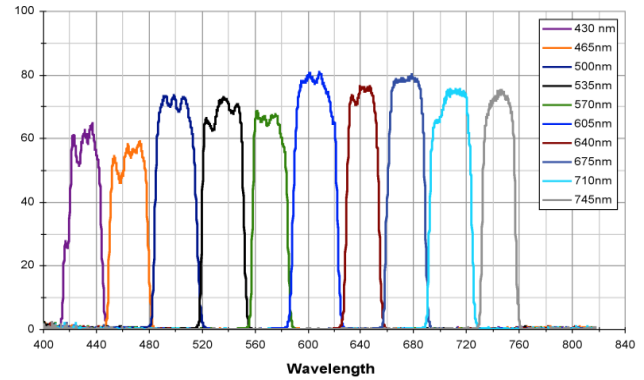

18 emission filters (20 nm bandwidth)

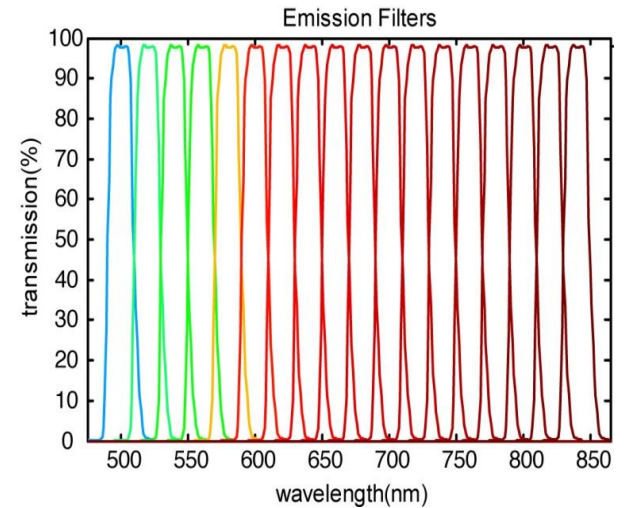

Basic Methodology

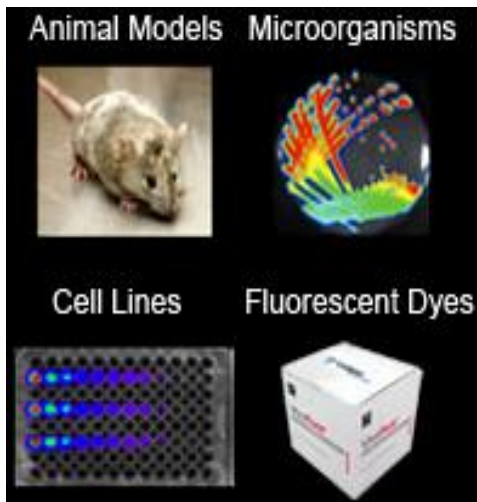

Biological Reporters Imaging Hardware Imaging Software

Reporter Molecules

Luciferase,
Fluorescent
Protein

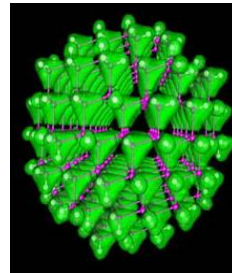
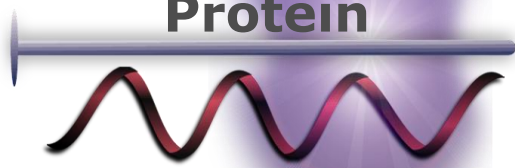

Quantum dots

Fluorescent dyes



ATP and O₂ required for luciferase

Label Cells

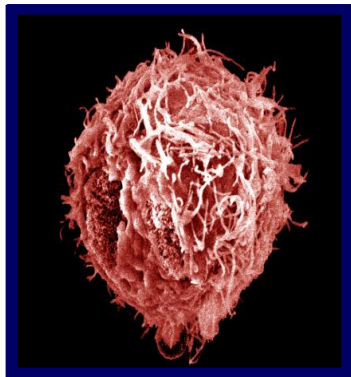

Label Bacteria

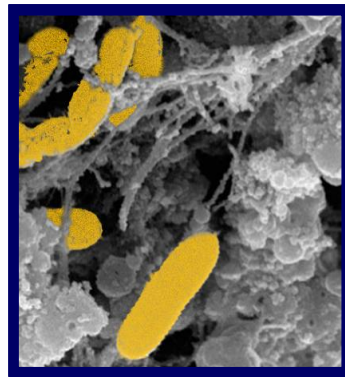

Label Genes

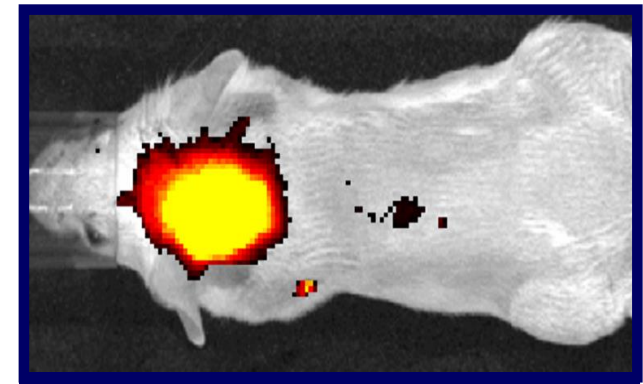

Comparison of Epi and Trans Illumination

Epi-Illumination Reveals Shallow Signals Better Than Trans-Illumination, But Offers Limited Sensitivity For Deep Tissue Fluorescence Imaging

Surface (shallow depth) signal

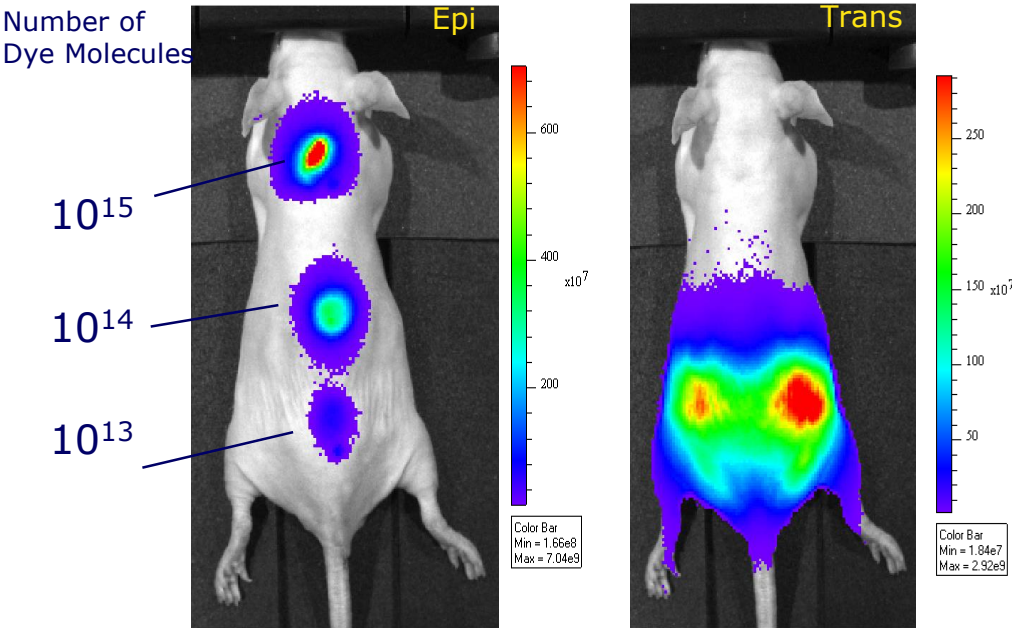

Deep Tissue signal

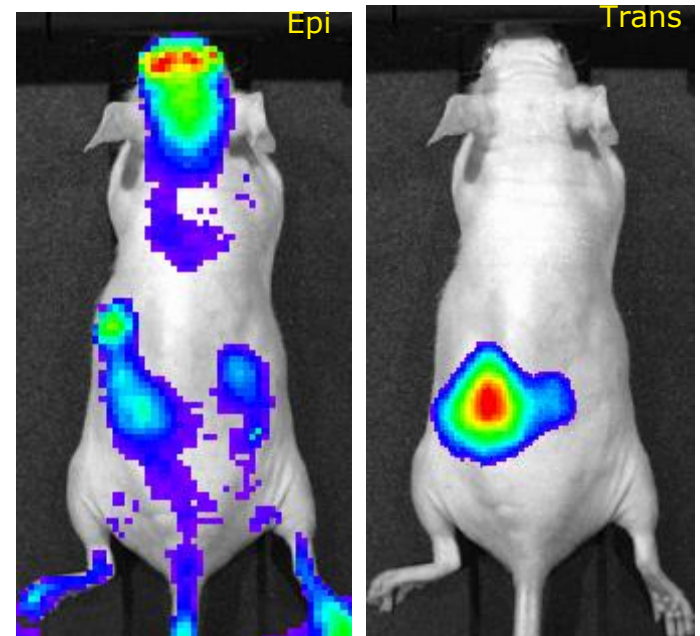

Different Concentrations of Alexafluor 680 dye molecules injected subcutaneously

Pillow Containing 1×10^{15} molecules of Alexafluor 680 Dye implanted medial to left kidney

Ex: 620 nm / Em:700 nm

Cell Transplantation and Trafficking Patterns

Stem Cell Foci Formation and Hematopoiesis

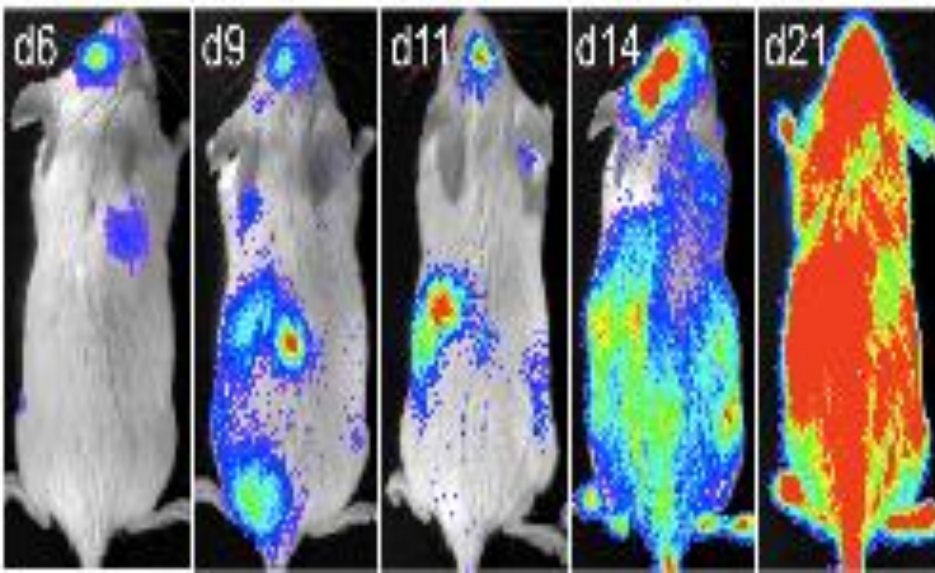

Transplantation of 250 Luc+ HSC into Lethally Irradiated Hosts

Cao et al, Stem Cells, 2004

Stem Cell Viability

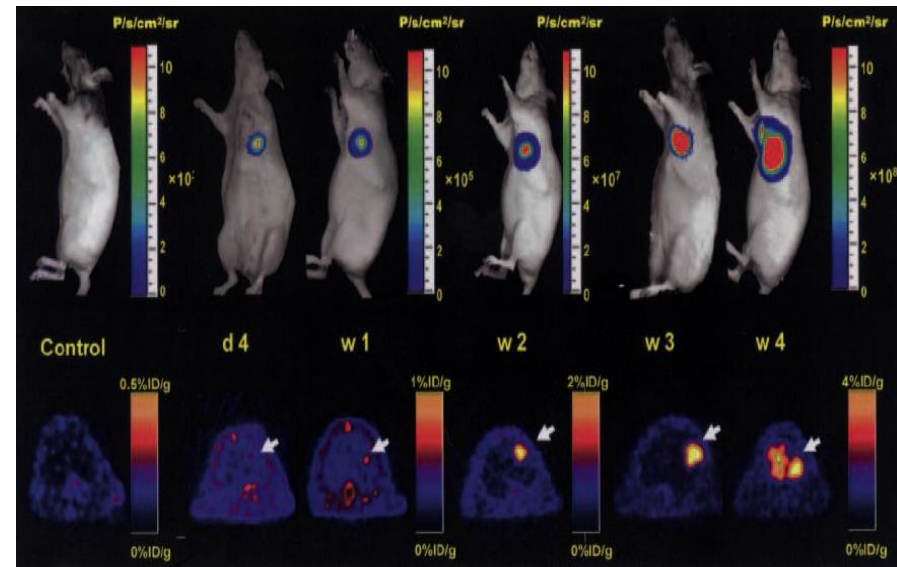

In Vivo Visualization of ES Cell Survival, Proliferation, and Migration After Cardiac Delivery

Cao et al, Circulation, 2006